

CERTIFIED PRODUCT AND ACCESSORIES (ABBREVIATED CATALOG)

THE FULL NIGHT IMPRESSIONS CATALOG CAN BE FOUND AT HPCFIRE.COM/SUPPORT

FIRE • WATER • FIRE AND WATER

2017-2018 Outdoor Product Catalog



COMMERCIAL
AND RESIDENTIAL
OUTDOOR PRODUCTS



Hearth Products Controls
Fire Inspired Since 1975

TABLE OF CONTENTS

- 4 MAP Policy - Minimum Advertised Price
- 6 Warranty Program
- 7 **Fire Pit Controls...Explained**
- 12 **Fire Pit Inserts:** Round Insert Models
- 16 Square Insert Models
- 18 Rectangle Insert Models
- 22 Linear Insert Models
- 26 **Control Options-** Inserts
- 27 Push Button Ignition Kits- Unassembled (FPK)
- 28 Match Lit Kits- Unassembled (FPS)
- 31 Ready to Finish Packages - Enclosures
- 38 Copper Bowl Series- Fire, Fire/Water
- 40 Water Feature Inserts - Info
- 42 Evolution 360 Series- Fire and Water
- 43 H2Onfire Series- Fire On Water
- 44 TK Torch Series
- 46 **Accessories** Glass Wind Guards, Install Collars, Outdoor Logs, Lava Rock, Decorative Glass, Hard Covers, Vinyl Covers, Access Doors, Vents, Ready-to-Finish Enclosures
- 52 Flame Control Systems
- 53 **Outdoor Burners**
- 58 **Fire Pit Components:** Pans, Flex Line, Decorative Key Valves, Regulators, Igniters
- 62 **Replacement Components**
- 65 **APPENDIX- Accessories for Inserts**
- 69 P.O.P Products - Showroom Displays

CONTACT



Hearth Products Controls Co

**3050 Plainfield Rd
Kettering, OH 45432
Phone: 877.433.7001
Fax: 877.433.0704**

Email: orders@hpcfire.com



hpcfire.com

Revision 2 - Printed Oct. 2016

COVER PHOTO

Courtesy of SE Design and Construction - Pennsylvania

WHO WE ARE

Hearth Products Controls Company (HPC) was originally a division of The Maddox Company (founded by Dan Maddox) incorporated on December 1, 1975. TMC was active in the hearth products industry as a manufacturers representative, one step & two-step distributor, and as a manufacturing division. The HPC division began in 1989; HPC was split off as a separate corporation in 2001.

The foundation of the company was built on safety pilot valve, millivolt valve, and remote control kits / repair parts, as well as various other components for the hearth industry. We then diversified our thinking by introducing the Outdoor Fire Products line in 2003 with the manufacturing of fire rings. Today this segment of the business has grown to include over 300 CSA Certified Models with various technologies including match lit, manual spark/flame sense and high-end remote electronic ignition fire pit inserts. Also available are TK Torches, copper water bowls, outdoor accessories, and a selection of stainless steel components second to none.

HPC also designs custom fire features and their control systems in many shapes and sizes for residential or commercial applications. These range from 2 feet to 50 feet wide, from 50 thousand Btus or more. These fire features - found at large venues throughout the world including casinos, resorts, and restaurants. HPC is committed to R&D of current and new product.

We are located in Kettering, Ohio. Our facility houses manufacturing, warehouse & of course the always helpful office staff. We have a very diverse, experienced and knowledgeable group of Sales Reps throughout the U.S. & Canada that cover every state & region. We have numerous distributors & retailers in North America in industries including hearth, landscape, pool & spa, outdoor kitchen, patio furniture, and outdoor lighting just to name a few. For your support, we have staff that is second to none as our NFI Certified technical support and management team understands the industry and your needs.

OUR OPERATING STANDARDS

- Value every customer regardless of size.
- Treat customers, as we would like our sources to treat us.
- Make products that are as widely applicable as possible.
- Use the best possible components in our products.
- Keep overhead as low as we can, consistent with good service and fair prices.
- Continuously looking for ways to improve our present products and services as well as searching for additional services and products our customers want or need.
- Be professional in all actions, products, and materials.
- Keep as aware as we can of industry trends and changes.
- Keep our inventories at a level consistent with quick and complete shipment of orders.



Photo Courtesy of Rustic Decor - Arizona

MISSION STATEMENT

HPC will strive to be the leader in our industry through safe, innovative, high quality products and more importantly provide excellent customer service, training, and education to our valued customers and community.



WHAT WE DO

Working within our mission statement and operating standards HPC does the following and much more!

- *Develop, construct, and package the most useful and easy to use kits in our industry for gas log repair.*
- *Offer custom kits to meet any customer needs with our label, no label or with our customer's label.*
- *Have components manufactured just for our use which are the best on the market.*
- *Provide a variety of products to assist in the installation and servicing of hearth products.*
- *Provide excellent customer service & state-of-the-art NFI-Certified technical support for our kits and products.*
- *Offer broad line of outdoor burners including our patented Penta burners, fire rings, H-Burners, T-Burners, linear, and dual burners.*
- *CSA Certification on over 300 models of match-lit, push button and electronic ignition fire pits inserts.*
- *Design & build custom fire pit inserts and burners.*
- *Orders are shipped within 2 - 5 days upon receipt of PO for majority of product.*
- *Always offer a live attendant on our phone lines 8:00AM–5:00PM, Monday–Friday, Eastern Standard Time.*
- *R&D Strong - always engineering and developing innovative, safe products.*
- *Product safety is our top priority - to educate both dealers and end users on safe installation and operation of products.*
- *Offer a diverse line of products from indoor hearth to outdoor fire, and unique innovative water features.*
- *Also have after hours voice mail and website is available 24/7 at www.hpcfire.com*

SMALL ORDER SURCHARGE

We have a small order surcharge on orders of \$50.00 or less.
Surcharge of \$5.00 is applied to orders of \$0.01–\$24.99
Surcharge of \$3.00 is applied to orders of \$25.00–\$49.99

FREIGHT POLICY

Most orders will be shipped FOB Kettering, Ohio, with a standard shipping carrier selected by HPC unless customer specifically requests their own carrier and account. A handling fee will be charged for use of non-standard HPC carriers. A freight quote may be requested in advance. HPC works diligently with standard carriers to achieve the best discounts available.

Need help? Use our fire pit selector at hpcfire.com

LIVE BURN PROGRAM

You will receive credit for future purchases on the following products that you install in a live burn display at your facility or your outdoor demo area. Purchase these products, install in live burn area, take a picture of the live burn demo and forward it with your request for credit. Please note this is not an up front discount. If live burn credit request is not received in 30 days, credit will be applied to account when approved. (Payment is due in full Net 30.) Fifty percent (50%) credit of the demo items will be applied to your account on a manual control valve kit, safety pilot kit, millivolt kit, and CSA-Certified fire pit inserts. Ten percent (10%) credit on demo of Evolution 360 Series. The live burn demo credit does not apply to custom products, complete packages (Copper Bowls and Enclosures), individual components and media.

CREDIT POLICY

All shipments are billed in US Dollars and must be paid in US Dollars. Our regular terms are Net 30 days from the invoice date.

- 1 *If an invoice becomes 10 days past due, the account may be placed on credit hold. Placing an account on credit hold restricts the shipment of future orders.*
- 2 *When an invoice becomes 15 days past due, we reserve the option to apply a 1.5% per month finance charge back to the due date of the invoice and for any 30 day period going forward in which the invoice remains unpaid. The account terms may be changed to Credit Card or Cash in Advance.*
- 3 *If an invoice becomes 30 days past due, your account may be referred to an outside collection agency unless we have jointly agreed to a payment schedule or plan.*
- 4 *When the account is referred to a collection agency, the collection charges must be repaid. Also, we reserve the right to make the account terms Credit Card, or Cash in Advance.*
- 5 *Any discounts received on a delinquent invoice may be revoked and expected to be paid. HPC reserves the right to discontinue future discounts.*
- 6 *Customers receiving regular discount and/or volume order discount must pay by check, not credit card.*
- 7 *Net 30 invoices must be paid via check. Use of credit card is not allowed on invoices where terms have been extended.*

If you ever have a temporary payment issue or we have made a mistake on an invoice, please call us immediately to discuss and resolve the problem.

Sincerely,
Greg Steck

A handwritten signature in black ink that reads "Greg Steck". The signature is written in a cursive style with a large "G" and "S".

President
Hearth Products Controls Co.

We accept:



MINIMUM ADVERTISED PRICING (MAP) POLICY

Look for:
MAP
APPLIES



Hearth Products Controls Company (the "Company") has unilaterally adopted this Minimum Advertised Pricing policy ("Policy"). This Policy is subject to change at any time by the Company at its sole discretion.

- 1. Purpose:** The purpose of this policy is to protect the value of the Company's trademarks and brand names and to attract and retain reputable, customer-friendly resellers.
- 2. Scope:** This Policy is applicable to all sellers of the Company's products (the "Products") who advertise or sell Products on any platform ("Resellers") and to distributors ("Distributors") that sell to such Resellers. This Policy applies to all Products of the Company unless otherwise specified by the Company. The Policy applies to prices advertised anywhere including but not limited to magazines, newspapers, flyers, catalogs, coupons, mailers, television, radio, signs, websites, social media, order entry/purchase order forms, direct e-mail advertising and related materials that are accessible through the Internet platform(s) by means of a hyperlink.

The Policy does NOT apply to advertising displayed only in the store and not distributed to the customer for Products to be sold in-store.

This Policy does NOT apply to the price at which the Products are actually sold. Nothing in the Policy or other agreement with the Company will constitute an agreement on the price or price levels at which Resellers or Distributors actually sell any Product.

- 3. Minimum Advertised Price (MAP):** The advertised price of a Product means the net price advertised after all discounts, rebates, gifts or promotional items. The Minimum Advertised Price ("MAP") shall be set by the Company from time to time in its sole discretion and shall be communicated by the Company to the Resellers from time to time. If the Company makes the MAP available on a website accessible to the Reseller and informs Reseller of this, it is the responsibility of the Reseller to maintain current knowledge of the MAP.

- 4. Policy on Price Advertising:** It is the policy of the Company that Resellers shall not advertise any Company Product at prices below the MAP for that Product established by the Company. This policy is not violated by Reseller advertising a higher price. Also, this policy is not violated by communication by email or telephone to an individual customer in response to a telephone or email inquiry from the customer. Statements such as "call for pricing" for a Product do not violate the Policy as long as a price for the Product is provided on the same paper or website and that price is equal to or exceeds the MAP. Also, it is a violation of this Policy for the Reseller to characterize or disclose any pricing as the minimum advertised price or that such minimum is based on the Company's policies. Resellers and Distributors have not agreed to this unilateral Policy and the Company is not seeking any such agreement. However, if a Reseller or a Distributor violates this Policy, the Company's policy is to take certain unilateral actions.

- 5. Actions by the Company:** The Company has the right to sell Products to each Reseller or Distributor or to refrain or stop from doing in its discretion for any reason or for no reason. Under this Policy, if Reseller advertises Products below the MAP or otherwise violates this Policy, the Company may cease selling or shipping Products to Reseller or its customers and/or cease taking orders from Reseller for a temporary or permanent period in the Company's discretion, which may take into account circumstances such as the number of violations or the repetition of violations. Also, if a Distributor sells Product to any Reseller that violates this Policy, the Distributor will be in violation of the Policy and the Company may cease selling or shipping Products to that Distributor or its customers and/or cease taking orders from that Distributor for a temporary or permanent period in the Company's discretion, which may take into account circumstances such as the number of violations or the repetition of violations. The Company will take these actions unilaterally and will not seek or accept any agreement by a Reseller or a Distributor or any assurance of future compliance by that Reseller or Distributor.

- 6. Contact Information:** Company sales personnel have no authority to modify or grant exceptions to this Policy. All questions or comments regarding this Policy should be directed to the policy administrator at info@hpcfire.com.

Photo Courtesy of Swim World Pools - TN

Our Water feature inserts (pg. 36) are relaxing on a primal level, with the subtle sounds of running water and flames licking into the wind, it will draw anyone near it in.

PRODUCT RETURN POLICY

All returned product must have an RMA (Return Merchandise Authorization) issued by one of our technical support staff, so please call to get an RMA. To get an RMA please have your original purchase information available and contact the technical support staff. A support person will attempt to solve the problem over the telephone. If the technical support staff cannot troubleshoot the problem over the phone, a RMA and a return services label will be issued.

The RMA number must be indicated on the outside of the returned package and a copy of RMA paperwork should be within the package. The RMA is valid for 30 days after issued. Once we receive the product back, testing will begin.

It is important to note the complete unit must be returned in order to test the product. If all parts needed to test the unit are not returned, parts needed will be charged to the customer and unit will be returned complete to the customer. If you have any questions on what should be returned, please contact the technical support staff.



Photo Courtesy of The Hearth Shop - California

PRODUCT TESTING PROGRAM

A Product Testing Report will be filled out by our testing department showing what was found in testing and the disposition of tested products.

DEFECTIVE: If an item is found to be defective it will be repaired or replaced at our discretion. HPC will absorb all costs of incoming/outgoing freight and replacement or repair costs if product is in warranty.

NON-DEFECTIVE: If the product is found to be non-defective it will be returned to the customer — no credit will be given. Freight in and freight out are at customers expense.

HPC ERROR: If a return is needed due to a mistake on our part, we will issue a RMA and Return Services Label. When products are received at HPC, credit will be issued for the products and the outgoing freight on the original invoice.

CUSTOMER ERROR: If an RMA is asked for and covers current new products in the original package, we will authorize the return. The customer is responsible for the return shipping. When products are received we will issue credit for the original customer cost less a 20% restocking charge. Custom orders do not apply.

EXCESS INVENTORY: If due to excess customer inventory (of current new products in original packages only) we may issue a RMA. The customer is responsible for the return shipping. When products are received we will issue credit for the original customer cost less a 20% restocking charge.

REMOTE CONTROLS: Please confirm you have replaced the batteries in the handheld remote and receiver and reprogrammed the remote before returning the unit to Hearth Products Controls under warranty. If your remote is found to be non-defective except for weak or bad batteries, you will be charged for any freight charges incurred for the return.



WARRANTY PROGRAM

Hearth Products Controls Company warranties product against manufacturing defects that prevent safe and correct operation of the product commencing from the date of original sale or shipment from HPC. The warranty on parts and in-house labor will apply only to claims presented to us by our original customer and is in lieu of all other warranties expressed or implied. Please refer to the Warranty Chart below for warranty periods.

The defective product must be shipped back with an RMA (Return Merchandise Authorization) issued by HPC for that specific product which states the nature of the defect or warranty claim. Product to be returned should be packed carefully—HPC is not responsible for shipping damage on returned items. The original purchase information will be required. RMA's are only valid for 30 days from the date of issue by HPC and will not be processed if received after the expiration date. The RMA number must be indicated on the outside of the return package and a copy of the RMA should be placed in the package with product.

Our warranty does not cover items that have been damaged by over heating, modification, abuse, improper storage, installation, or maintenance. This warranty excludes claims for incidental or consequential damage and indirect-collateral expenses arising from product defects or warranty recovery. Appliances manufactured by HPC including CSA Certified models, cannot be altered or modified in any way.

Hearth Products Controls Company is not responsible for local codes and / or if any of our products are not approved for installation. Please check with your local authorities or governing agencies for proper approvals before purchasing. HPC is not responsible for the actions including negligence of the installer.



Photo Courtesy of Rick of Oregon - Oregon

WARRANTY POLICY

Components	Application	
	Residential	Commercial
Outdoor Fire Components		
Electronic Components and Gas Valves	3 years	1 year
Pilot Assembly	2 years	1 year
Stainless Steel Components	5 year	1 year
Cold Rolled Steel Components	1 year	6 months
Outdoor Logs	5 years	5 years
Unfinished Fire Pit Enclosure	5 years	5 years
Copper Bowl Series <i>(Normal Weathering Expected)</i>	3 years	3 years
Aluminum Fire Pit Covers	3 years	3 years
Evolution360™ & H2Onfire Series		
Polyethylene Basin and Liner	3 years	3 year
Water Pump	2 years	1 year
Float and Sensor	2 years	1 year
Hose and Fittings	2 years	2 years
Electronics and LEDs	2 years	1 year

HPC FIRE PIT CONTROLS *Explained*



THE NEXT 3 PAGES WILL HELP DECIDE...

- How to light the fire pit?
- Does the fire pit need flame sensing?

HPC OFFERS THREE FLAME CONTROL OPTIONS FOR OUR CERTIFIED FIRE PIT INSERTS- ALL OF WHICH OFFER OPTIONS THAT BEST FIT YOUR NEEDS.



1

Remote Electronic Ignition (EI Series)
(Pg. 8)



2

Push Button / Flame Sense (FPPK Series)
(Pg. 9)



3

Match Lit System (MLFPK Series)
(Pg. 10)



Photo Courtesy of Rustic Decor - Arizona

① REMOTE ELECTRONIC IGNITION CONTROL (EI SERIES)

This is our top-of-the-line system featuring the ignition ease with use of a wall switch or handheld remote to control flame as well as auto-relight if flame loss. This year we are launching a new control system with numerous convenience and performance improvements for both On/Off Models and our newly introduced High/Low Models- such as High/Low flame control via our new remote, a redesigned hot surface igniter and many other improvements.

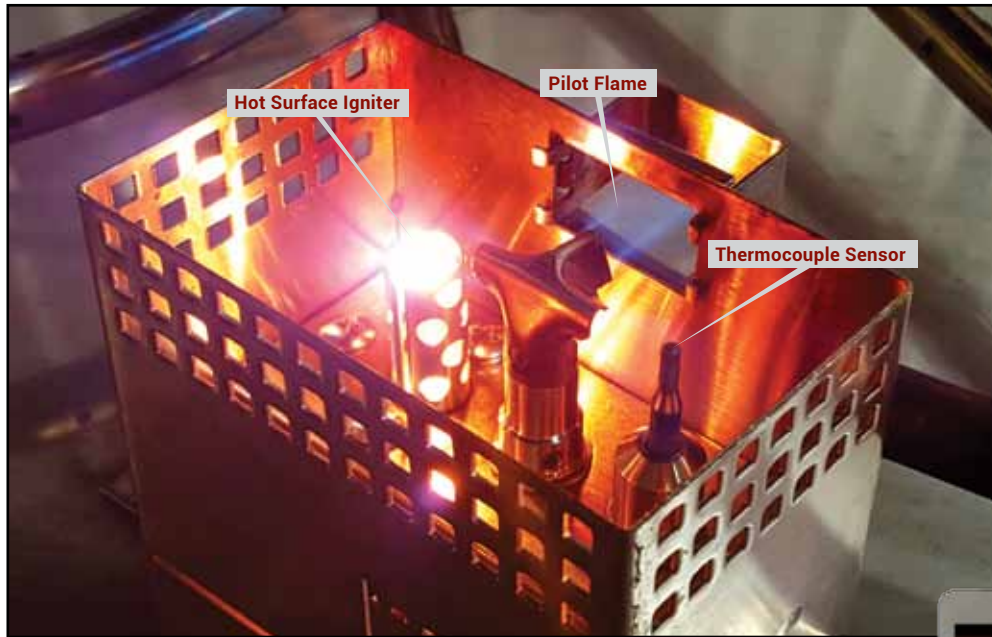

Igniter / Sensor are protected from outdoor elements in the blowout box



Smart device App available on Hi/Lo Models only

How It Works

Start Up: This is done by use of a wall switch or remote control. When the ON command is received, the system completes initial safety checks then starts flow of pilot gas. After 5 seconds the hot surface igniter glows igniting pilot flame. When the system confirms pilot flame present, the main burner gas will flow ignited by the pilot flame.

Operation: While enjoying the ambiance of your fire pit, the system is at work monitoring flame status, internal temperatures / voltages and other safety parameters. If flame loss does occur, the system will turn off all gas flow, and then restart by automatically commencing Start sequence.

On/Off Models: Includes the convenience and safety features- optional remote control available.

High / Low Flame Control Models: This option includes a smart remote and App via smart device control with 2-way communication with the fire pit. Remote allows flame height control while receiving information from fire pit to advise user of fire pit status (flashing LED).

Shut Down: To turn OFF the fire pit simply use wall switch, remote control or whole house system.

Features

- Fully Assembled- ready to install. Control components are protected within valve box.
- Start via wall switch or remote control; Auto re-light if flame is lost.
- Ignition is complete using a robust and reliable Hot Surface igniter.
- On/Off models: Use with optional wall switch, Remote Control or your whole house system
- High/Low Flame Control Models: Adjust high setting to low setting- ~45% turndown (Remote Control included). Not for use with your whole house system.
- 120vac: Standard outdoor grounded power cord- simply plug into GFCI outlet.
- 24vac Option: Typically used pool side or with other lower voltage requirements.
- Natural Gas or Liquid Propane: Factory built & tested for either fuel.
- Internal temperature monitoring with overheat auto shutoff.
- CSA Certified in US & Canada to ANSI Z21.97-2014 / CSA 2.41-2014 requirements. (This new EI system already meets upcoming 2018 ANSI requirements).
- Optional Controls: On/Off Remote, Timers, Power Supplies and an Emergency Shutoff. (Pg. 26)

② PUSH BUTTON / FLAME SENSE CONTROL (FPPK SERIES)

This is our mid-range fire pit insert utilizing safety pilot flame control- simply push ignition button and valve control knob to start... flame adjustment is done with knob. This battery operated system is a good solution for flame sensing necessity without AC power requirements.

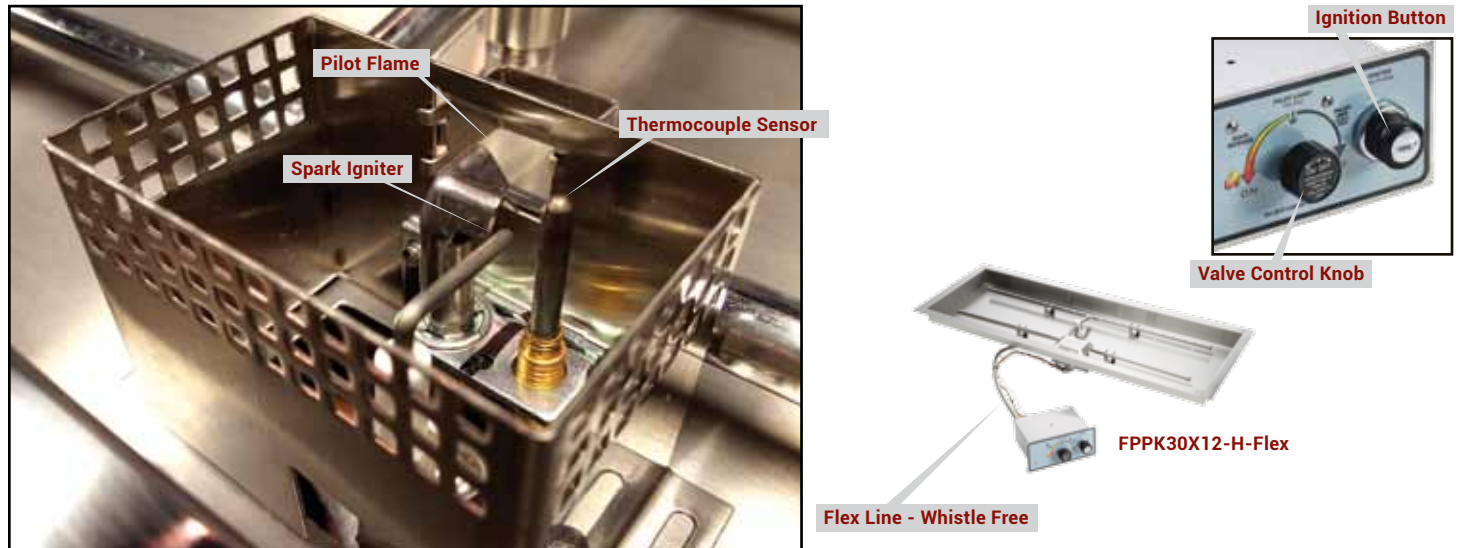

Igniter / Sensor are protected from outdoor elements in the blowout box

How It Works

Start Up: This is done by simultaneously pressing valve control knob to start flow of pilot gas and pressing ignition button for spark. Release spark after pilot ignition, release valve control knob after ~20 seconds. Then turn valve control knob counterclockwise to light main burner.

Operation: Flame height may be adjusted by turning valve control knob- counterclockwise provides more flame, clockwise lowers flame. If flame loss does occur, the system will automatically turn off all gas flow.

Shut Down: To turn OFF the fire pit simply turn valve control knob clockwise- slightly depress knob to reach OFF position.

Features

- Fully Assembled and ready to install. Control components are protected within valve box.
- Flex Line configuration provides versatile and simple installation.
- Start ignition with push button and valve control knob.
- Flame sensing- system will turn off gas if flame is lost.
- Flame height is adjustable using valve control knob.
- Battery Operated System- is perfect solution for installs with no power.
- Natural Gas or Liquid Propane: Factory built & tested for either fuel.
- CSA Certified in US & Canada to ANSI Z21.97-2014 / CSA 2.41-2014 requirements.
- Optional Install: Control Box Sleeve for mounting in pavers, metal and more. (Pg. 27)

③ MATCH LIT (MLFPK SERIES)

This is our simplest certified fire pit insert- easy to operate and requires the least amount of maintenance.



30" X 12" Match Lit
(MLFPK-FLEX)



MLFPK Paver Bracket - Pg. 25
(Optional)



How It Works

Start Up: This is done by lighting long-stem lighter next to perimeter of burner then slowly open key to valve. Leave key in valve during use.

Operation: Flame height may be adjusted by turning key to valve- counterclockwise provides more flame, clockwise lowers flame.

Shut Down: To turn OFF the fire pit simply turn key to valve clockwise to OFF position. Remove key.

Features

- Fully Assembled and ready to install.
- Flex Line configuration provides versatile and simple installation.
- Valve mounting bracket included- for safe mounting of control have.
- Flame height is adjustable using key valve.
- Natural Gas or Liquid Propane: Factory built & tested for either fuel.
- CSA Certified in US & Canada to ANSI Z21.97-2014 / CSA 2.41-2014 requirements.
- Optional Install & Controls: Paver Block Bracket, Key Extension Kit, and Long Keys.

WHY CHOOSE A PENTA BURNER

OVER OTHER RINGS & BURNERS?

HPC has been the leader in fire ring and burner technology since 2003- launching numerous innovative designs including linear trough, dual burner and our original gas fire ring.



In 2012, HPC introduced the Penta Burner- a very unique and innovative burner design that delivers a very full campfire effect...much more evident than any other burner or fire ring on the market. This is accomplished by the 12 & 3 o'clock burner ports on each lobe of the burner (except on the lobe tips) by design to reduce risk of excessive heat exposure to enclosure cap. This port design also prevents a distinct burner pattern when on lower flame setting- unlike many fire rings or burners.

The Penta Burner design requires less fuel to deliver the same flame height versus other fire rings resulting in lower cost to operate. The Penta Burner has received multiple Utility and

Design Patents highlighting the innovation, technology and unique appearance behind the design.

Features

- Made of #304 Stainless Steel with a 5 year warranty.
- Raised-hub design prevents water from entering gas valve.
- Burner ports drilled at 12 & 3 o'clock positions for full flame.
- No distinct burner pattern at low setting.
- Low profile design requires less lava, glass or other media.
- Full range of sizes- from 12" to 48" available.
- Patented Technology- Utility and Design Patents Apply



SPIDER GUARD

SAFETY AND PROTECTION FROM HPC

It is a known fact that spiders are very attracted to LP gas. Over the years we occasionally see a clogged air mixer / orifice due to a spider nest, resulting in a gas leak out the venturi and filling the fire pit cavity. To prevent this, all certified LP fire pits will utilize a "spider guard" to prevent this potentially serious situation.



ROUND INSERT MODELS

FULLY ASSEMBLED, COMMERCIAL GRADE, CERTIFIED INSERTS

All fire pit inserts come fully assembled and include installation and operation instructions.

ROUND BOWL INSERTS

An HPC original- this stainless steel, spun bowl design was launched in 2004...and today is still our most popular pan style.

Benefits: Sidewall helps with media retention; Pan Lip provides for recessed burner / blowout box.

Features:

- Made of #304, 18 gauge Stainless Steel
- Spun design adds rigidity
- Welded gas fitting for strength
- Weep holes for drainage

EI MODELS INCLUDE:

Insert: Fully Assembled
Flex Line: Gas Input
Instructions



Penta 31" Electronic Ignition (EI)

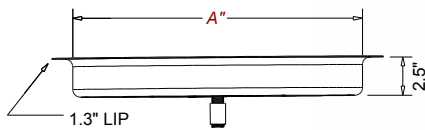

Accessories (Pg. 26):
Timers
Power Supplies
E-Stop



SOLD SEPARATELY:

On/Off Models 120VAC- Remote: 578-C: See Pg. 26

Vinyl Cover: See Chart on Pg. 65

Lava Rock / Glass: See Chart on Pg. 65



**See Pg. 8 for
EI System Features**

Electronic Ignition Models - EI Series Specifications

Size (A")	Power	Gas type	Model - Flame ON/OFF	Model - Flame Adjustment (HI/LO)	Burner	Max BTU
				HI/LO MODELS COME WITH REMOTE (this column only)		
13"	120vac	Natural Gas	13SSEI-NG/120VAC	13SSEI-HI/LO-NG/120VAC	12" Round	90k
		Liquid Propane	13SSEI-LP/120VAC	13SSEI-HI/LO-LP/120VAC		
	24vac	Natural Gas	13SSEI-NG/24VAC	13SSEI-HI/LO-NG/24VAC		
		Liquid Propane	13SSEI-LP/24VAC	13SSEI-HI/LO-LP/24VAC		
19"	120vac	Natural Gas	PENTA19EI-NG/120VAC	PENTA19EI-HI/LO-NG/120VAC	12" Penta	65k
		Liquid Propane	PENTA19EI-LP/120VAC	PENTA19EI-HI/LO-LP/120VAC		
	24vac	Natural Gas	PENTA19EI-NG/24VAC	PENTA19EI-HI/LO-NG/24VAC		
		Liquid Propane	PENTA19EI-LP/24VAC	PENTA19EI-HI/LO-LP/24VAC		
25"	120vac	Natural Gas	PENTA25EI-NG/120VAC	PENTA25EI-HI/LO-NG/120VAC	18" Penta	125k
		Liquid Propane	PENTA25EI-LP/120VAC	PENTA25EI-HI/LO-LP/120VAC		
	24vac	Natural Gas	PENTA25EI-NG/24VAC	PENTA25EI-HI/LO-NG/24VAC		
		Liquid Propane	PENTA25EI-LP/24VAC	PENTA25EI-HI/LO-LP/24VAC		
31"	120vac	Natural Gas	PENTA31EI-NG/120VAC	PENTA31EI-HI/LO-NG/120VAC	24" Penta	200k
		Liquid Propane	PENTA31EI-LP/120VAC	PENTA31EI-HI/LO-LP/120VAC		
	24vac	Natural Gas	PENTA31EI-NG/24VAC	PENTA31EI-HI/LO-NG/24VAC		
		Liquid Propane	PENTA31EI-LP/24VAC	PENTA31EI-HI/LO-LP/24VAC		
37"	120vac	Natural Gas	PENTA37EI-NG/120VAC	PENTA37EI-HI/LO-NG/120VAC	30" Penta	250k
		Liquid Propane	PENTA37EI-LP/120VAC	PENTA37EI-HI/LO-LP/120VAC		
	24vac	Natural Gas	PENTA37EI-NG/24VAC	PENTA37EI-HI/LO-NG/24VAC		
		Liquid Propane	PENTA37EI-LP/24VAC	PENTA37EI-HI/LO-LP/24VAC		
43"	120vac	Natural Gas	PENTA43EI-NG/120VAC	N/A	36" Penta	400k
		Liquid Propane	PENTA43EI-LP/120VAC	N/A		
	24vac	Natural Gas	PENTA43EI-NG/24VAC	N/A		
		Liquid Propane	PENTA43EI-LP/24VAC	N/A		

**Match proper accessories to your
fire pit model - see Pg. 65-68.**



Penta 31" Push Button/Flame Sense (FPPK-FLEX)

Penta 25" Match Lit (MLFPK-FLEX)

Accessories:



Media Pg. 46
Outdoor Logs Pg. 48
Hard Covers Pg. 49



SOLD SEPARATELY:
Input Flex Line: SSC-HC24: All models
Vinyl Cover: See Chart on Pg. 67
Lava Rock / Glass: See Chart on Pg. 67

FPPK & MLFPK MODELS INCLUDE:
Insert: Fully Assembled
Instructions

Push Button/Flame Sense Models - FPPK Flex Series Specifications

See Pg. 9 for FPPK System Features

Size (A")	Gas type	Model	Burner	Max BTU	* Flex Line
13"	Natural Gas	FPPK13-FLEX-NG	12" Round	90k	36"
	Liquid Propane	FPPK13-FLEX-LP			
19"	Natural Gas	PENTA19FPPK-FLEX-NG	12" Penta	65k	36"
	Liquid Propane	PENTA19FPPK-FLEX-LP			
25"	Natural Gas	PENTA25FPPK-FLEX-NG	18" Penta	90k	36"
	Liquid Propane	PENTA25FPPK-FLEX-LP			
31"	Natural Gas	PENTA31FPPK-FLEX-NG	24" Penta	140k	36"
	Liquid Propane	PENTA31FPPK-FLEX-LP			
37"	Natural Gas	PENTA37FPPK-FLEX-NG	30" Penta	140k	36"
	Liquid Propane	PENTA37FPPK-FLEX-LP			

LP Small Tank - CSA Certified for use. (See Pg.27)

*Between valve and burner



SOLD SEPARATELY:
Input Flex Line: SSC24: All models
Vinyl Cover: See Chart on Pg. 68
Lava Rock / Glass: See Chart on Pg. 68

Match Lit Models - MLFPK Flex Series Specifications

See Pg. 10 for MLFPK System Features

Size (A")	Gas type	Model	Burner	Max BTU	* Flex Line
13"	Natural Gas	PENTA13 MLFPK-FLEX-NG	12" Penta	65k	36"
	Liquid Propane	PENTA13 MLFPK-FLEX-LP			
19"	Natural Gas	PENTA19 MLFPK-FLEX-NG	12" Penta	65k	36"
	Liquid Propane	PENTA19 MLFPK-FLEX-LP			
25"	Natural Gas	PENTA25 MLFPK-FLEX-NG	18" Penta	65k	36"
	Liquid Propane	PENTA25 MLFPK-FLEX-LP			
31"	Natural Gas	PENTA31 MLFPK-FLEX-NG	18" Penta	65k	36"
	Liquid Propane	PENTA31 MLFPK-FLEX-LP			

LP Small Tank - CSA Certified for use. (See Pg.27)

*Between valve and burner

ROUND INSERT MODELS (CONTINUED)

FULLY ASSEMBLED, COMMERCIAL GRADE, CERTIFIED INSERTS

All fire pit inserts come fully assembled and include installation and operation instructions.

ROUND FLAT INSERTS

Benefits: Economical flat design- used in enclosures that have recess mount and internal sidewalls for media.

Features:

- Made of #304, 18 gauge Stainless Steel
- Raised hub burner for water prevention
- Welded gas fitting for strength
- Weep holes for drainage

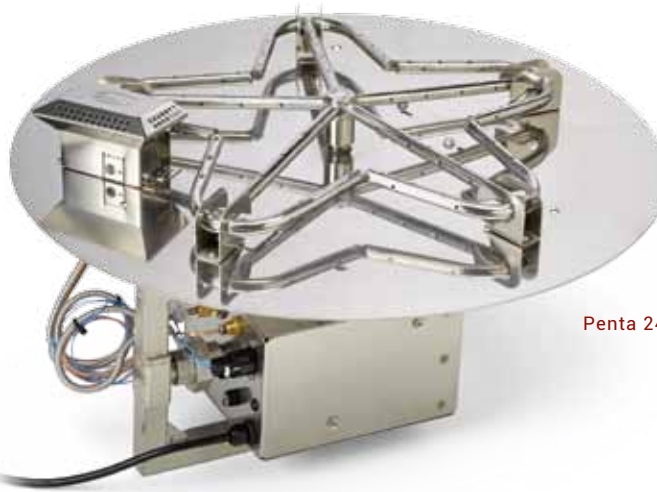

EI MODELS INCLUDE:
Insert: Fully Assembled
Flex Line: Gas Input
Instructions

Penta 24" Electronic Ignition (EI)

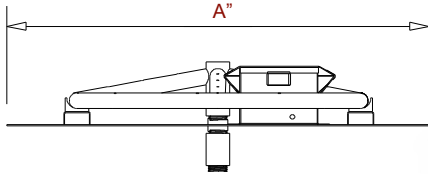

Accessories (Pg. 26):
Timers
Power Supplies
E-Stop



SOLD SEPARATELY:

- On/Off Models 120VAC- Remote: 578-C: See Pg. 26
- Vinyl Cover: See Chart on Pg. 65
- Lava Rock / Glass: See Chart on Pg. 65



**See Pg. 8 for
EI System Features**

Electronic Ignition Models - EI Series Specifications

Size (A")	Power	Gas type	Model - Flame ON/OFF	Model - Flame Adjustment (HI/LO)	Burner	Max BTU
				HI/LO MODELS COME WITH REMOTE (this column only)		
14"	120vac	Natural Gas	14FSSEI-NG/120VAC	14FSSEI-HI/LO-NG/120VAC	12" Round	90k
		Liquid Propane	14FSSEI-LP/120VAC	14FSSEI-HI/LO-LP/120VAC		
14"	24vac	Natural Gas	14FSSEI-NG/24VAC	14FSSEI-HI/LO-NG/24VAC	⊗	
		Liquid Propane	14FSSEI-LP/24VAC	14FSSEI-HI/LO-LP/24VAC		
18"	120vac	Natural Gas	PENTA18EI-NG/120VAC	PENTA18EI-HI/LO-NG/120VAC	12" Penta	65k
		Liquid Propane	PENTA18EI-LP/120VAC	PENTA18EI-HI/LO-LP/120VAC		
18"	24vac	Natural Gas	PENTA18EI-NG/24VAC	PENTA18EI-HI/LO-NG/24VAC	★	
		Liquid Propane	PENTA18EI-LP/24VAC	PENTA18EI-HI/LO-LP/24VAC		
24"	120vac	Natural Gas	PENTA24EI-NG/120VAC	PENTA24EI-HI/LO-NG/120VAC	18" Penta	125k
		Liquid Propane	PENTA24EI-LP/120VAC	PENTA24EI-HI/LO-LP/120VAC		
24"	24vac	Natural Gas	PENTA24EI-NG/24VAC	PENTA24EI-HI/LO-NG/24VAC	★	
		Liquid Propane	PENTA24EI-LP/24VAC	PENTA24EI-HI/LO-LP/24VAC		
30"	120vac	Natural Gas	PENTA30EI-NG/120VAC	PENTA30EI-HI/LO-NG/120VAC	24" Penta	200k
		Liquid Propane	PENTA30EI-LP/120VAC	PENTA30EI-HI/LO-LP/120VAC		
30"	24vac	Natural Gas	PENTA30EI-NG/24VAC	PENTA30EI-HI/LO-NG/24VAC	★	
		Liquid Propane	PENTA30EI-LP/24VAC	PENTA30EI-HI/LO-LP/24VAC		
36"	120vac	Natural Gas	PENTA36EI-NG/120VAC	PENTA36EI-HI/LO-NG/120VAC	30" Penta	250k
		Liquid Propane	PENTA36EI-LP/120VAC	PENTA36EI-HI/LO-LP/120VAC		
36"	24vac	Natural Gas	PENTA36EI-NG/24VAC	PENTA36EI-HI/LO-NG/24VAC	★	
		Liquid Propane	PENTA36EI-LP/24VAC	PENTA36EI-HI/LO-LP/24VAC		
42"	120vac	Natural Gas	PENTA42EI-NG/120VAC	N/A	36" Penta	400k
		Liquid Propane	PENTA42EI-LP/120VAC	N/A		
42"	24vac	Natural Gas	PENTA42EI-NG/24VAC	N/A	★	
		Liquid Propane	PENTA42EI-LP/24VAC	N/A		
54"	120vac	Natural Gas	PENTA54EI-NG/120VAC	N/A	48" Penta	400k
		Liquid Propane	PENTA54EI-LP/120VAC	N/A		
54"	24vac	Natural Gas	PENTA54EI-NG/24VAC	N/A	★	
		Liquid Propane	PENTA54EI-LP/24VAC	N/A		

Match proper accessories to your fire pit model - see Pg. 65-68.



Penta 30" Push Button/Flame Sense (FPPK-FLEX)



Penta 24" Match Lit (MLFPK-FLEX)

FPPK & MLFPK MODELS INCLUDE:

Insert: Fully Assembled Instructions



SOLD SEPARATELY:

Input Flex Line: SSC-HC24: All models

Vinyl Cover: See Chart on Pg. 67

Lava Rock / Glass: See Chart on Pg. 67

Accessories:



Media Pg. 46
Outdoor Logs Pg. 48
Hard Covers Pg. 49

Push Button/Flame Sense Models - FPPK Flex Series Specifications

See Pg. 9 for FPPK System Features

Size	Gas type	Model	Burner	Max BTU	* Flex Line
14"	Natural Gas	FPPK14-FLEX-NG	12" Round	90k	36"
	Liquid Propane	FPPK14-FLEX-LP			
18"	Natural Gas	PENTA18FPPK-FLEX-NG	12" Penta	65k	36"
	Liquid Propane	PENTA18FPPK-FLEX-LP			
24"	Natural Gas	PENTA24FPPK-FLEX-NG	18" Penta	90k	36"
	Liquid Propane	PENTA24FPPK-FLEX-LP			
30"	Natural Gas	PENTA30FPPK-FLEX-NG	24" Penta	140k	36"
	Liquid Propane	PENTA30FPPK-FLEX-LP			
36"	Natural Gas	PENTA36FPPK-FLEX-NG	30" Penta	140k	36"
	Liquid Propane	PENTA36FPPK-FLEX-LP			

LP Small Tank - CSA Certified for use. (See Pg.27)

*Between valve and burner



SOLD SEPARATELY:

Input Flex Line: SSC24: All models

Vinyl Cover: See Chart on Pg. 68

Lava Rock / Glass: See Chart on Pg. 68

Match Lit Models - MLFPK Flex Series Specifications

See Pg. 10 for MLFPK System Features

Size	Gas type	Model	Burner	Max BTU	* Flex Line
8"	Natural Gas	MLFPK8-FLEX-NG	6" Round	40k	36"
	Liquid Propane	MLFPK8-FLEX-LP			
14"	Natural Gas	PENTA14 MLFPK-FLEX-NG	12" Penta	65k	36"
	Liquid Propane	PENTA14 MLFPK-FLEX-LP			
18"	Natural Gas	PENTA18 MLFPK-FLEX-NG	12" Penta	65k	36"
	Liquid Propane	PENTA18 MLFPK-FLEX-LP			
24"	Natural Gas	PENTA24 MLFPK-FLEX-NG	18" Penta	65k	36"
	Liquid Propane	PENTA24 MLFPK-FLEX-LP			
30"	Natural Gas	PENTA30 MLFPK-FLEX-NG	18" Penta	65k	36"
	Liquid Propane	PENTA30 MLFPK-FLEX-LP			

LP Small Tank - CSA Certified for use. (See Pg.27)

*Between valve and burner

SQUARE INSERT MODELS

FULLY ASSEMBLED, COMMERCIAL GRADE, CERTIFIED INSERTS

All fire pit inserts come fully assembled and include installation and operation instructions.

MAP
APPLIES

SQUARE FLAT INSERTS

Benefits: Economical flat, square design- used in enclosures that have recess mount and internal sidewalls for media.

Features:

- Made of #304, 18 gauge Stainless Steel
- Raised hub burner for water prevention
- Welded gas fitting for strength
- Weep holes for drainage

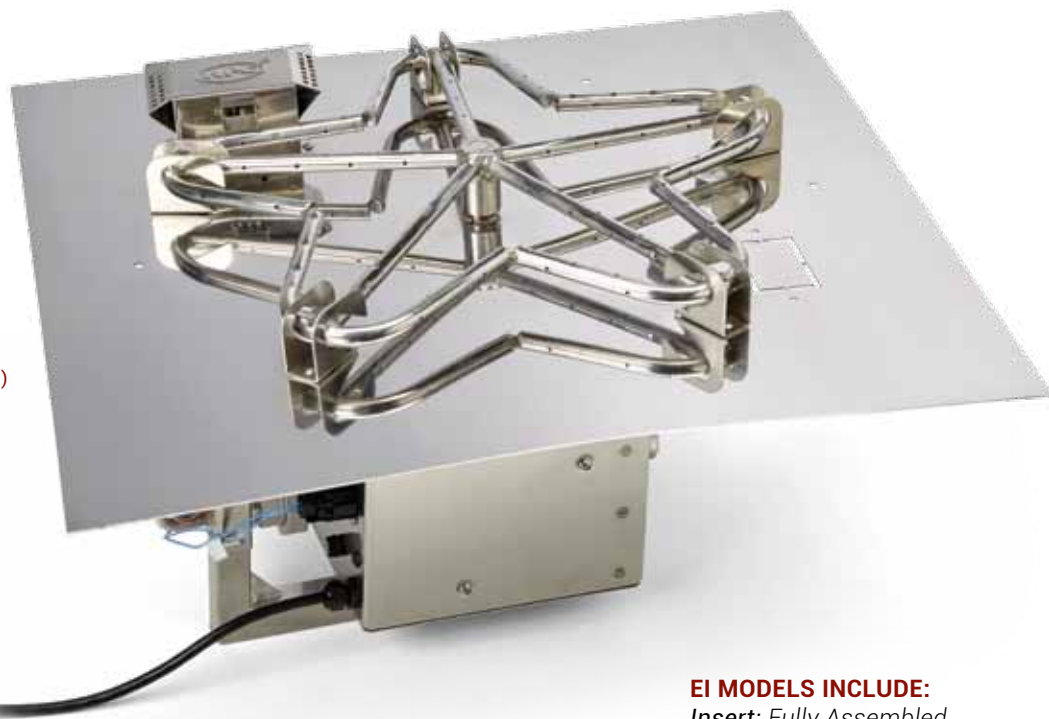

24" Square Electronic Ignition (EI)

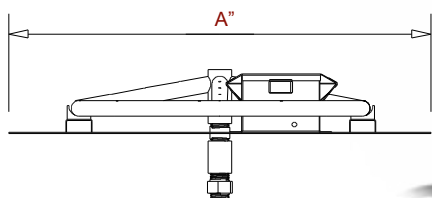

EI MODELS INCLUDE:
Insert: Fully Assembled
Flex Line: Gas Input
Instructions

Accessories (Pg. 26):
Timers
Power Supplies
E-Stop



SOLD SEPARATELY:

On/Off Models 120VAC- Remote: 578-C: See Pg. 26

Vinyl Cover: See Chart on Pg. 65

Lava Rock / Glass: See Chart on Pg. 65



See Pg. 8 for
EI System Features

Electronic Ignition Models - EI Series Specifications

Size (A")	Power	Gas type	Model - Flame ON/OFF	Model - Flame Adjustment (HI/LO)	Burner	Max BTU
				HI/LO MODELS COME WITH REMOTE (this column only)		
18"	120vac	Natural Gas	18FSSEI-SQ-NG/120VAC	18FSSEI-SQ-HI/LO-NG/120VAC	12" Penta	65k
		Liquid Propane	18FSSEI-SQ-LP/120VAC	18FSSEI-SQ-HI/LO-LP/120VAC		
	24vac	Natural Gas	18FSSEI-SQ-NG/24VAC	18FSSEI-SQ-HI/LO-NG/24VAC		
		Liquid Propane	18FSSEI-SQ-LP/24VAC	18FSSEI-SQ-HI/LO-LP/24VAC		
24"	120vac	Natural Gas	24FSSEI-SQ-NG/120VAC	24FSSEI-SQ-HI/LO-NG/120VAC	18" Penta	125k
		Liquid Propane	24FSSEI-SQ-LP/120VAC	24FSSEI-SQ-HI/LO-LP/120VAC		
	24vac	Natural Gas	24FSSEI-SQ-NG/24VAC	24FSSEI-SQ-HI/LO-NG/24VAC		
		Liquid Propane	24FSSEI-SQ-LP/24VAC	24FSSEI-SQ-HI/LO-LP/24VAC		
30"	120vac	Natural Gas	30FSSEI-SQ-NG/120VAC	30FSSEI-SQ-HI/LO-NG/120VAC	24" Penta	200k
		Liquid Propane	30FSSEI-SQ-LP/120VAC	30FSSEI-SQ-HI/LO-LP/120VAC		
	24vac	Natural Gas	30FSSEI-SQ-NG/24VAC	30FSSEI-SQ-HI/LO-NG/24VAC		
		Liquid Propane	30FSSEI-SQ-LP/24VAC	30FSSEI-SQ-HI/LO-LP/24VAC		
36"	120vac	Natural Gas	36FSSEI-SQ-NG/120VAC	36FSSEI-SQ-HI/LO-NG/120VAC	30" Penta	250k
		Liquid Propane	36FSSEI-SQ-LP/120VAC	36FSSEI-SQ-HI/LO-LP/120VAC		
	24vac	Natural Gas	36FSSEI-SQ-NG/24VAC	36FSSEI-SQ-HI/LO-NG/24VAC		
		Liquid Propane	36FSSEI-SQ-LP/24VAC	36FSSEI-SQ-HI/LO-LP/24VAC		
42"	120vac	Natural Gas	42FSSEI-SQ-NG/120VAC	N/A	36" Penta	400k
		Liquid Propane	42FSSEI-SQ-LP/120VAC	N/A		
	24vac	Natural Gas	42FSSEI-SQ-NG/24VAC	N/A		
		Liquid Propane	42FSSEI-SQ-LP/24VAC	N/A		

Match proper accessories to your fire pit model - see Pg. 65-68.



30" Square Push Button/Flame Sense (FPPK-FLEX)

24" Square Match Lit (MLFPK-FLEX)

FPPK & MLFPK MODELS INCLUDE:

Insert: Fully Assembled Instructions



SOLD SEPARATELY:

Input Flex Line: SSC-HC24: All models

Vinyl Cover: See Chart on Pg. 67

Lava Rock / Glass: See Chart on Pg. 67

Accessories:



MLFPK Paver Bracket - Pg. 27



FPPK Mounting Sleeve - Pg. 27

Media Pg. 46
Outdoor Logs Pg. 48
Hard Covers Pg. 49

Push Button/Flame Sense Models - FPPK Flex Series Specifications

See Pg. 9 for FPPK System Features

Size	Gas type	Model	Burner	Max BTU	* Flex Line
18"	Natural Gas	FPPK18-SQ-FLEX-NG	12" Penta	65k	36"
	Liquid Propane	FPPK18-SQ-FLEX-LP			
24"	Natural Gas	FPPK24-SQ-FLEX-NG	18" Penta	90k	36"
	Liquid Propane	FPPK24-SQ-FLEX-LP			
30"	Natural Gas	FPPK30-SQ-FLEX-NG	24" Penta	140k	36"
	Liquid Propane	FPPK30-SQ-FLEX-LP			
36"	Natural Gas	FPPK36-SQ-FLEX-NG	30" Penta	140k	36"
	Liquid Propane	FPPK36-SQ-FLEX-LP			

LP Small Tank - CSA Certified for use. (See Pg.27)

*Between valve and burner



SOLD SEPARATELY:

Input Flex Line: SSC24: All models

Vinyl Cover: See Chart on Pg. 68

Lava Rock / Glass: See Chart on Pg. 68

Match Lit Models - MLFPK Flex Series Specifications

See Pg. 10 for MLFPK System Features

Size	Gas type	Model	Burner	Max BTU	* Flex Line
18"	Natural Gas	MLFPK18SQ-FLEX-NG	12" Penta	65k	36"
	Liquid Propane	MLFPK18SQ-FLEX-LP			
24"	Natural Gas	MLFPK24SQ-FLEX-NG	18" Penta	65k	36"
	Liquid Propane	MLFPK24SQ-FLEX-LP			
30"	Natural Gas	MLFPK30SQ-FLEX-NG	18" Penta	65k	36"
	Liquid Propane	MLFPK30SQ-FLEX-LP			

LP Small Tank - CSA Certified for use. (See Pg.27)

*Between valve and burner

RECTANGLE INSERT MODELS (CONTINUED)

MAP APPLIES

FULLY ASSEMBLED, COMMERCIAL GRADE, CERTIFIED INSERTS

All fire pit inserts come fully assembled and include installation and operation instructions.

H-BURNER INSERTS

36" X 14" Electronic Ignition (EI)

Benefits: Sidewall helps with media retention; Pan Lip provides for recessed burner / blowout box.

Features:

Made of #304, 18 gauge Stainless Steel
Raised hub H-burner for water prevention
Bolted gas fitting for strength
Weep holes for drainage

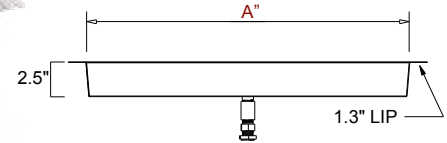
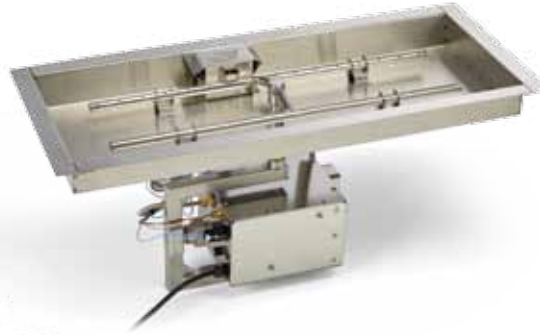

EI MODELS INCLUDE:
Insert: Fully Assembled
Flex Line: Gas Input
Instructions

Accessories (Pg. 26):

Timers
Power Supplies
E-Stop



SOLD SEPARATELY:

On/Off Models 120VAC- Remote: 578-C: See Pg. 26

Vinyl Cover: See Chart on Pg. 65

Lava Rock / Glass: See Chart on Pg. 65



**See Pg. 8 for
EI System Features**

Electronic Ignition Models - EI Series Specifications

Size (A")	Power	Gas type	Model - Flame ON/OFF	Model - Flame Adjustment (HI/LO)	Burner	Max BTU
				HI/LO MODELS COME WITH REMOTE (this column only)		
24" X 12"	120vac	Natural Gas	24X12SSEI-H-NG/120VAC	24X12SSEI-H-HI/LO-NG/120VAC	18" X 6" H-Burner	75k
		Liquid Propane	24X12SSEI-H-LP/120VAC	24X12SSEI-H-HI/LO-LP/120VAC		
	24vac	Natural Gas	24X12SSEI-H-NG/24VAC	24X12SSEI-H-HI/LO-NG/24VAC		
		Liquid Propane	24X12SSEI-H-LP/24VAC	24X12SSEI-H-HI/LO-LP/24VAC		
30" X 12"	120vac	Natural Gas	30X12SSEI-H-NG/120VAC	30X12SSEI-H-HI/LO-NG/120VAC	24" X 6" H-Burner	100k
		Liquid Propane	30X12SSEI-H-LP/120VAC	30X12SSEI-H-HI/LO-LP/120VAC		
	24vac	Natural Gas	30X12SSEI-H-NG/24VAC	30X12SSEI-H-HI/LO-NG/24VAC		
		Liquid Propane	30X12SSEI-H-LP/24VAC	30X12SSEI-H-HI/LO-LP/24VAC		
36" X 14"	120vac	Natural Gas	36X14SSEI-H-NG/120VAC	36X14SSEI-H-HI/LO-NG/120VAC	30" X 8" H-Burner	125k
		Liquid Propane	36X14SSEI-H-LP/120VAC	36X14SSEI-H-HI/LO-LP/120VAC		
	24vac	Natural Gas	36X14SSEI-H-NG/24VAC	36X14SSEI-H-HI/LO-NG/24VAC		
		Liquid Propane	36X14SSEI-H-LP/24VAC	36X14SSEI-H-HI/LO-LP/24VAC		
42" X 14"	120vac	Natural Gas	42X14SSEI-H-NG/120VAC	42X14SSEI-H-HI/LO-NG/120VAC	36" X 8" H-Burner	150k
		Liquid Propane	42X14SSEI-H-LP/120VAC	42X14SSEI-H-HI/LO-LP/120VAC		
	24vac	Natural Gas	42X14SSEI-H-NG/24VAC	42X14SSEI-H-HI/LO-NG/24VAC		
		Liquid Propane	42X14SSEI-H-LP/24VAC	42X14SSEI-H-HI/LO-LP/24VAC		
54" X 16"	120vac	Natural Gas	54X16SSEI-H-NG/120VAC	54X16SSEI-H-HI/LO-NG/120VAC	48" X 10" H-Burner	200k
		Liquid Propane	54X16SSEI-H-LP/120VAC	54X16SSEI-H-HI/LO-LP/120VAC		
	24vac	Natural Gas	54X16SSEI-H-NG/24VAC	54X16SSEI-H-HI/LO-NG/24VAC		
		Liquid Propane	54X16SSEI-H-LP/24VAC	54X16SSEI-H-HI/LO-LP/24VAC		
66" X 16"	120vac	Natural Gas	66X16SSEI-H-NG/120VAC	66X16SSEI-H-HI/LO-NG/120VAC	60" X 10" H-Burner	250k
		Liquid Propane	66X16SSEI-H-LP/120VAC	66X16SSEI-H-HI/LO-LP/120VAC		
	24vac	Natural Gas	66X16SSEI-H-NG/24VAC	66X16SSEI-H-HI/LO-NG/24VAC		
		Liquid Propane	66X16SSEI-H-LP/24VAC	66X16SSEI-H-HI/LO-LP/24VAC		
78" X 16"	120vac	Natural Gas	78X16SSEI-H-NG/120VAC	78X16SSEI-H-HI/LO-NG/120VAC	72" X 10" H-Burner	300k
		Liquid Propane	78X16SSEI-H-LP/120VAC	78X16SSEI-H-HI/LO-LP/120VAC		
	24vac	Natural Gas	78X16SSEI-H-NG/24VAC	78X16SSEI-H-HI/LO-NG/24VAC		
		Liquid Propane	78X16SSEI-H-LP/24VAC	78X16SSEI-H-HI/LO-LP/24VAC		
90" X 16"	120vac	Natural Gas	90X16SSEI-H-NG/120VAC	NA	84" X 10" H-Burner	350k
		Liquid Propane	90X16SSEI-H-LP/120VAC	NA		
	24vac	Natural Gas	90X16SSEI-H-NG/24VAC	NA		
		Liquid Propane	90X16SSEI-H-LP/24VAC	NA		



42" X 14" Push Button/Flame Sense (FPPK-FLEX)

30" X 12" Match Lit (MLFPK-FLEX)



SOLD SEPARATELY:
Input Flex Line: SSC-HC24: All models
Vinyl Cover: See Chart on Pg. 67
Lava Rock / Glass: See Chart on Pg. 67

FPPK & MLFPK MODELS INCLUDE:
Insert: Fully Assembled
Instructions

Accessories:



Media Pg. 46
Outdoor Logs Pg. 48
Hard Covers Pg. 49

Push Button/Flame Sense Models - FPPK Flex Series Specifications

See Pg. 9 for FPPK System Features

Size	Gas type	Model	Burner	Max BTU	* Flex Line
24" X 12"	Natural Gas	FPPK24X12-H-FLEX-NG	18" X 6"	75k	36"
	Liquid Propane	FPPK24X12-H-FLEX-LP	H Burner		
30" X 12"	Natural Gas	FPPK30X12-H-FLEX-NG	24" X 6"	90k	36"
	Liquid Propane	FPPK30X12-H-FLEX-LP	H burner		
36" X 14"	Natural Gas	FPPK36X14-H-FLEX-NG	30" X 8"	90k	36"
	Liquid Propane	FPPK36X14-H-FLEX-LP	H Burner		
42" X 14"	Natural Gas	FPPK42X14-H-FLEX-NG	36" X 8"	140k	36"
	Liquid Propane	FPPK42X14-H-FLEX-LP	H Burner		
54" X 16"	Natural Gas	FPPK54X16-H-FLEX-NG	48" X 10"	140k	36"
	Liquid Propane	FPPK54X16-H-FLEX-LP	H Burner		

LP Small Tank - CSA Certified for use. (See Pg.27)

*Between valve and burner



SOLD SEPARATELY:
Input Flex Line: SSC24: All models
Vinyl Cover: See Chart on Pg. 68
Lava Rock / Glass: See Chart on Pg. 68

Match Lit Models - MLFPK Flex Series Specifications

See Pg. 10 for MLFPK System Features

Size	Gas type	Model	Burner	Max BTU	* Flex Line
24" X 12"	Natural Gas	MLFPK24X12-H-FLEX-NG	18" X 6"	65k	36"
	Liquid Propane	MLFPK24X12-H-FLEX-LP	H Burner		
30" X 12"	Natural Gas	MLFPK30X12-H-FLEX-NG	24" X 6"	65k	36"
	Liquid Propane	MLFPK30X12-H-FLEX-LP	H Burner		
36" X 14"	Natural Gas	MLFPK36X14-H-FLEX-NG	30" X 8"	65k	36"
	Liquid Propane	MLFPK36X14-H-FLEX-LP	H Burner		

LP Small Tank - CSA Certified for use. (See Pg.27)

*Between valve and burner

RECTANGLE INSERT MODELS (CONTINUED)

MAP APPLIES

FULLY ASSEMBLED, COMMERCIAL GRADE, CERTIFIED INSERTS

All fire pit inserts come fully assembled and include installation and operation instructions.

S-FIRE BURNER INSERTS

Benefits: Sidewall helps with media retention; Pan Lip provides for recessed burner / blowout box.

Features:

Made of #304, 18 gauge Stainless Steel
Raised hub H-burner for water prevention
Bolted gas fitting for strength
Weep holes for drainage



EI MODELS INCLUDE:

Insert: Fully Assembled
Flex Line: Gas Input
Instructions

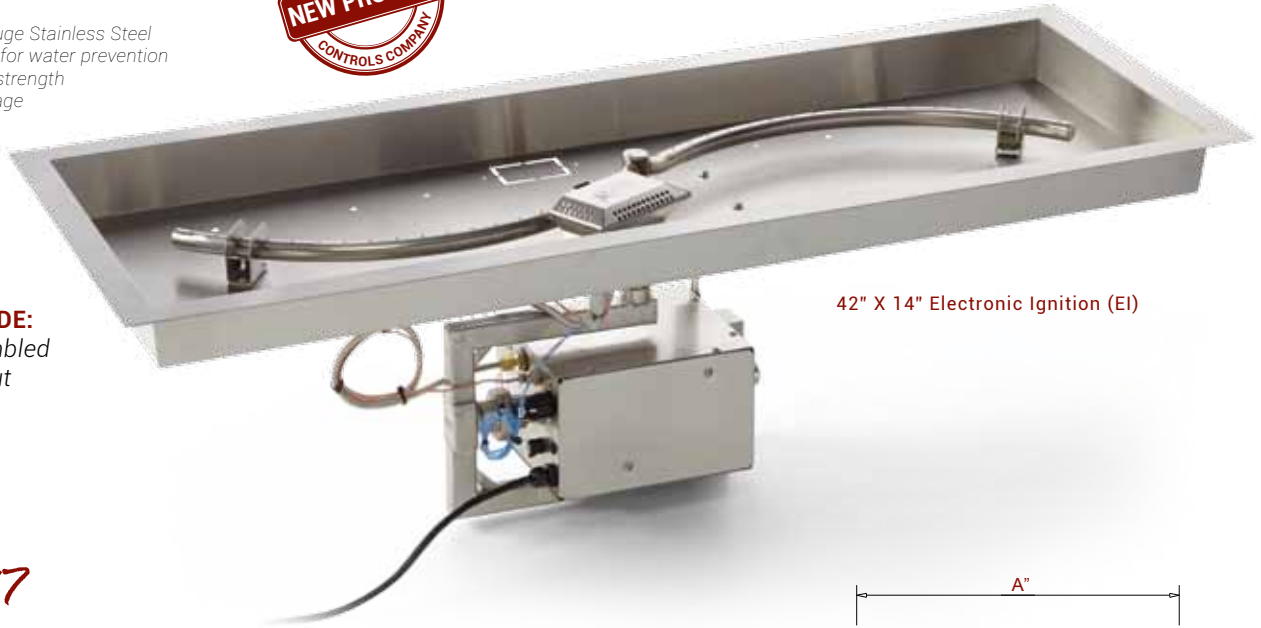

EI MODELS INCLUDE:

Insert: Fully Assembled
Flex Line: Gas Input
Instructions

42" X 14" Electronic Ignition (EI)

Available
June 2017

Accessories (Pg. 26):
Timers
Power Supplies
E-Stop



SOLD SEPARATELY:

On/Off Models 120VAC- Remote: 578-C: See Pg. 26
Vinyl Cover: See Chart on Pg. 65
Lava Rock / Glass: See Chart on Pg. 65

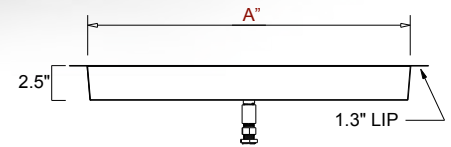

See Pg. 8 for
EI System Features

Electronic Ignition Models - EI Series Specifications

Size (A")	Power	Gas type	Model - Flame ON/OFF	Model - Flame Adjustment (HI/LO)	Burner	Max BTU
				HI/LO MODELS COME WITH REMOTE (this column only)		
36" X 14"	120vac	Natural Gas	36X14SSEI-S-NG/120VAC	36X14SSEI-S-HI/LO-NG/120VAC	30" X 8" S-Fire	75k
		Liquid Propane	36X14SSEI-S-LP/120VAC	36X14SSEI-S-HI/LO-LP/120VAC		
	24vac	Natural Gas	36X14SSEI-S-NG/24VAC	36X14SSEI-S-HI/LO-NG/24VAC		
		Liquid Propane	36X14SSEI-S-LP/24VAC	36X14SSEI-S-HI/LO-LP/24VAC		
42" X 14"	120vac	Natural Gas	42X14SSEI-S-NG/120VAC	42X14SSEI-S-HI/LO-NG/120VAC	36" X 8" S-Fire	85k
		Liquid Propane	42X14SSEI-S-LP/120VAC	42X14SSEI-S-HI/LO-LP/120VAC		
	24vac	Natural Gas	42X14SSEI-S-NG/24VAC	42X14SSEI-S-HI/LO-NG/24VAC		
		Liquid Propane	42X14SSEI-S-LP/24VAC	42X14SSEI-S-HI/LO-LP/24VAC		
54" X 16"	120vac	Natural Gas	54X16SSEI-S-NG/120VAC	54X16SSEI-S-HI/LO-NG/120VAC	48" X 10" S-Fire	110k
		Liquid Propane	54X16SSEI-S-LP/120VAC	54X16SSEI-S-HI/LO-LP/120VAC		
	24vac	Natural Gas	54X16SSEI-S-NG/24VAC	54X16SSEI-S-HI/LO-NG/24VAC		
		Liquid Propane	54X16SSEI-S-LP/24VAC	54X16SSEI-S-HI/LO-LP/24VAC		
66" X 16"	120vac	Natural Gas	66X16SSEI-S-NG/120VAC	66X16SSEI-S-HI/LO-NG/120VAC	60" X 10" S-Fire	135k
		Liquid Propane	66X16SSEI-S-LP/120VAC	66X16SSEI-S-HI/LO-LP/120VAC		
	24vac	Natural Gas	66X16SSEI-S-NG/24VAC	66X16SSEI-S-HI/LO-NG/24VAC		
		Liquid Propane	66X16SSEI-S-LP/24VAC	66X16SSEI-S-HI/LO-LP/24VAC		
78" X 16"	120vac	Natural Gas	78X16SSEI-S-NG/120VAC	78X16SSEI-S-HI/LO-NG/120VAC	72" X 10" S-Fire	165k
		Liquid Propane	78X16SSEI-S-LP/120VAC	78X16SSEI-S-HI/LO-LP/120VAC		
	24vac	Natural Gas	78X16SSEI-S-NG/24VAC	78X16SSEI-S-HI/LO-NG/24VAC		
		Liquid Propane	78X16SSEI-S-LP/24VAC	78X16SSEI-S-HI/LO-LP/24VAC		

Match proper accessories to your
fire pit model - see Pg. 65-68.



36" X 14" Match Lit (MLFPK-FLEX)



36" X 14" Push Button/Flame Sense (FPPK-FLEX)

Accessories:



MLFPK Paver Bracket - Pg. 27



FPPK Mounting Sleeve - Pg. 27

- Media Pg. 46
- Outdoor Logs Pg. 48
- Hard Covers Pg. 49

Available June 2017



SOLD SEPARATELY:

Input Flex Line: SSC-HC24: All models
 Vinyl Cover: See Chart on Pg. 67
 Lava Rock / Glass: See Chart on Pg. 67

FPPK & MLFPK MODELS INCLUDE:

Insert: Fully Assembled
 Instructions

Push Button/Flame Sense Models - FPPK Flex Series Specifications

See Pg. 9 for FPPK System Features

Size	Gas type	Model	Burner	Max BTU	* Flex Line
36" X 14"	Natural Gas	FPPK36X14-S-FLEX-NG	30" X 8"	75k	36"
	Liquid Propane	FPPK36X14-S-FLEX-LP	S-Fire		
42" X 14"	Natural Gas	FPPK42X14-S-FLEX-NG	36" X 8"	90k	36"
	Liquid Propane	FPPK42X14-S-FLEX-LP	S-Fire		
54" X 16"	Natural Gas	FPPK54X16-S-FLEX-NG	48" X 10"	140k	36"
	Liquid Propane	FPPK54X16-S-FLEX-LP	S-Fire		

LP Small Tank - CSA Certified for use. (See Pg.27)

*Between valve and burner



SOLD SEPARATELY:

Input Flex Line: SSC24: All models
 Vinyl Cover: See Chart on Pg. 68
 Lava Rock / Glass: See Chart on Pg. 68

Match Lit Models - MLFPK Flex Series Specifications

See Pg. 10 for MLFPK System Features

Size	Gas type	Model	Burner	Max BTU	* Flex Line
36" X 14"	Natural Gas	MLFPK36X14-S-FLEX-NG	30" X 8"	65k	36"
	Liquid Propane	MLFPK36X14-S-FLEX-LP	S-Fire		

LP Small Tank - CSA Certified for use. (See Pg.27)

*Between valve and burner

LINEAR INSERT MODELS

**MAP
APPLIES**

FULLY ASSEMBLED, COMMERCIAL GRADE, CERTIFIED INSERTS

All fire pit inserts come fully assembled and include installation and operation instructions.

LINEAR TROUGH INSERTS

The trough pan was introduced to industry by HPC in 2008- it is still a popular model with our Dealers.



60" Electronic Ignition (EI)

Benefits: V-Shape reduces amount of media; Sidewall helps with media retention; Pan Lip provides for recessed burner / blowout box.

Features:
Made of #304 Stainless Steel (48" and smaller- 18g, 60" and larger- 16g)
V-shape saves on media amount needed
Sidewalls adds rigidity- stronger than flat pans
Weep holes for drainage

EI MODELS INCLUDE:
Insert: Fully Assembled
Flex Line: Gas Input
Instructions

Accessories (Pg. 26):
Timers
Power Supplies
E-Stop



SOLD SEPARATELY:

On/Off Models 120VAC- Remote: 578-C: See Pg. 26

Vinyl Cover: See Chart on Pg. 65

Lava Rock / Glass: See Chart on Pg. 65



See Pg. 8 for EI System Features

Electronic Ignition Models - EI Series Specifications

Size (A")	Power	Gas type	Model - Flame ON/OFF	Model - Flame Adjustment (HI/LO)	Burner	Max BTU
				HI/LO MODELS COME WITH REMOTE (this column only)		
24"	120vac	Natural Gas	24SSEI-TRGH-NG/120VAC	24SSEI-TRGH-HI/LO-NG/120VAC	24"	50k
		Liquid Propane	24SSEI-TRGH-LP/120VAC	24SSEI-TRGH-HI/LO-LP/120VAC		
	24vac	Natural Gas	24SSEI-TRGH-NG/24VAC	24SSEI-TRGH-HI/LO-NG/24VAC	T-Burner	
		Liquid Propane	24SSEI-TRGH-LP/24VAC	24SSEI-TRGH-HI/LO-LP/24VAC		
36"	120vac	Natural Gas	36SSEI-TRGH-NG/120VAC	36SSEI-TRGH-HI/LO-NG/120VAC	36"	75k
		Liquid Propane	36SSEI-TRGH-LP/120VAC	36SSEI-TRGH-HI/LO-LP/120VAC		
	24vac	Natural Gas	36SSEI-TRGH-NG/24VAC	36SSEI-TRGH-HI/LO-NG/24VAC	T-Burner	
		Liquid Propane	36SSEI-TRGH-LP/24VAC	36SSEI-TRGH-HI/LO-LP/24VAC		
48"	120vac	Natural Gas	48SSEI-TRGH-NG/120VAC	48SSEI-TRGH-HI/LO-NG/120VAC	48"	100k
		Liquid Propane	48SSEI-TRGH-LP/120VAC	48SSEI-TRGH-HI/LO-LP/120VAC		
	24vac	Natural Gas	48SSEI-TRGH-NG/24VAC	48SSEI-TRGH-HI/LO-NG/24VAC	T-Burner	
		Liquid Propane	48SSEI-TRGH-LP/24VAC	48SSEI-TRGH-HI/LO-LP/24VAC		
60"	120vac	Natural Gas	60SSEI-TRGH-NG/120VAC	60SSEI-TRGH-HI/LO-NG/120VAC	60"	125k
		Liquid Propane	60SSEI-TRGH-LP/120VAC	60SSEI-TRGH-HI/LO-LP/120VAC		
	24vac	Natural Gas	60SSEI-TRGH-NG/24VAC	60SSEI-TRGH-HI/LO-NG/24VAC	T-Burner	
		Liquid Propane	60SSEI-TRGH-LP/24VAC	60SSEI-TRGH-HI/LO-LP/24VAC		
72"	120vac	Natural Gas	72SSEI-TRGH-NG/120VAC	72SSEI-TRGH-HI/LO-NG/120VAC	72"	150k
		Liquid Propane	72SSEI-TRGH-LP/120VAC	72SSEI-TRGH-HI/LO-LP/120VAC		
	24vac	Natural Gas	72SSEI-TRGH-NG/24VAC	72SSEI-TRGH-HI/LO-NG/24VAC	T-Burner	
		Liquid Propane	72SSEI-TRGH-LP/24VAC	72SSEI-TRGH-HI/LO-LP/24VAC		

Match proper accessories to your fire pit model - see Pg. 65-68.

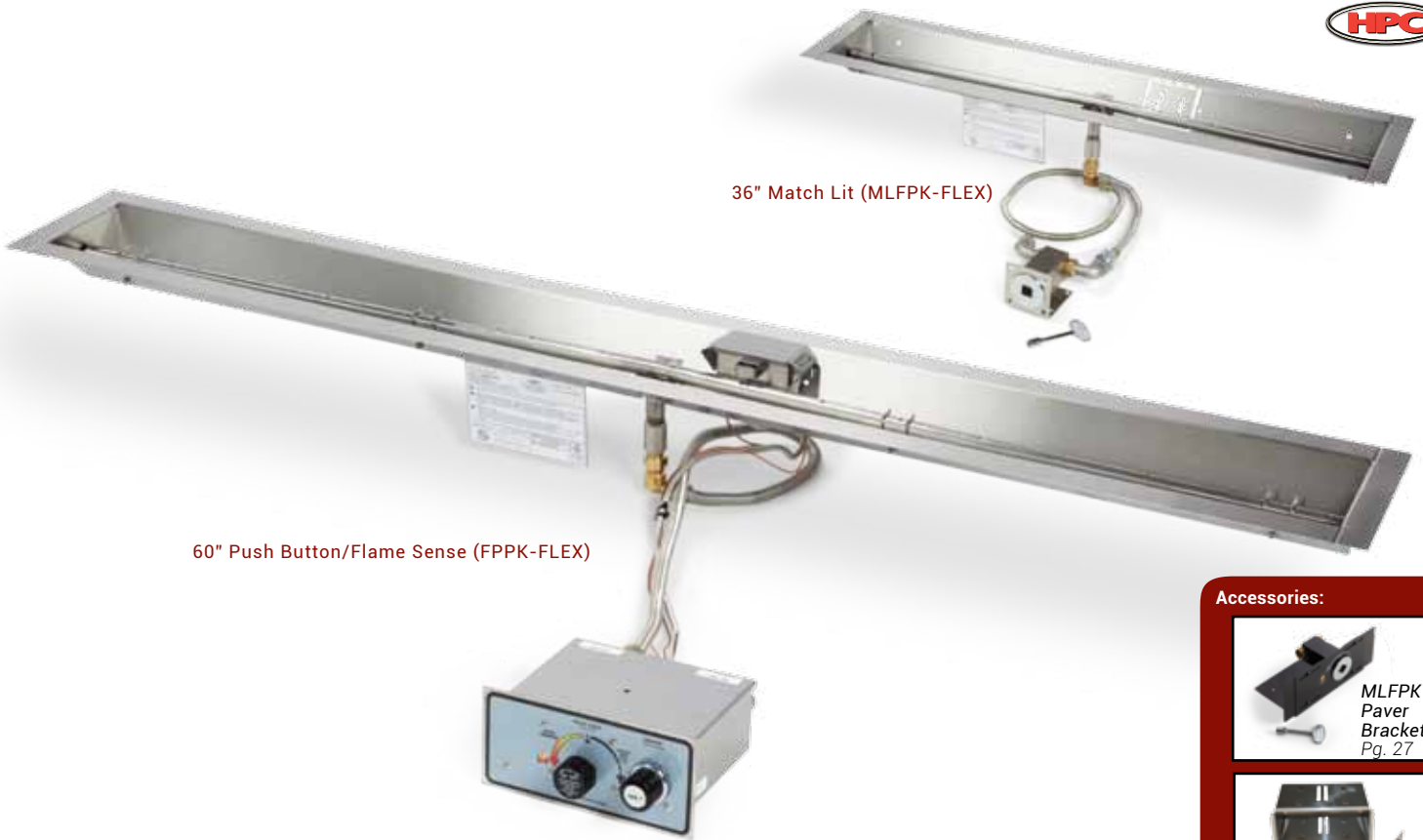

36" Match Lit (MLFPK-FLEX)

60" Push Button/Flame Sense (FPPK-FLEX)

Accessories:



Media Pg. 46
Outdoor Logs Pg. 48
Hard Covers Pg. 49



SOLD SEPARATELY:

Input Flex Line: SSC-HC24: All models
Vinyl Cover: See Chart on Pg. 67
Lava Rock / Glass: See Chart on Pg. 67

FPPK & MLFPK MODELS INCLUDE:

Insert: Fully Assembled
Instructions

Push Button/Flame Sense Models - FPPK Flex Series Specifications

See Pg. 9 for FPPK System Features

Size	Gas type	Model	Burner	Max BTU	* Flex Line
24"	Natural Gas	FPPK24-TRGH-FLEX-NG	24" T-Burner	50k	36"
	Liquid Propane	FPPK24-TRGH-FLEX-LP			
36"	Natural Gas	FPPK36-TRGH-FLEX-NG	36" T-Burner	75k	36"
	Liquid Propane	FPPK36-TRGH-FLEX-LP			
48"	Natural Gas	FPPK48-TRGH-FLEX-NG	48" T-Burner	90k	36"
	Liquid Propane	FPPK48-TRGH-FLEX-LP			
60"	Natural Gas	FPPK60-TRGH-FLEX-NG	60" T-Burner	90k	36"
	Liquid Propane	FPPK60-TRGH-FLEX-LP			
72"	Natural Gas	FPPK72-TRGH-FLEX-NG	72" T-Burner	140k	36"
	Liquid Propane	FPPK72-TRGH-FLEX-LP			

LP Small Tank - CSA Certified for use. (See Pg.27)

*Between valve and burner



SOLD SEPARATELY:

Input Flex Line: SSC24: All models
Vinyl Cover: See Chart on Pg. 68
Lava Rock / Glass: See Chart on Pg. 68

Match Lit Models - MLFPK Flex Series Specifications

See Pg. 10 for MLFPK System Features

Size	Gas type	Model	Burner	Max BTU	* Flex Line
24"	Natural Gas	MLFPK24 TRGH-FLEX-NG	24" T-Burner	50k	36"
	Liquid Propane	MLFPK24 TRGH-FLEX-LP			
36"	Natural Gas	MLFPK36 TRGH-FLEX-NG	36" T-Burner	65k	36"
	Liquid Propane	MLFPK36 TRGH-FLEX-LP			
48"	Natural Gas	MLFPK48 TRGH-FLEX-NG	48" T-Burner	65k	36"
	Liquid Propane	MLFPK48 TRGH-FLEX-LP			

LP Small Tank - CSA Certified for use. (See Pg.27)

*Between valve and burner

LINEAR INSERT MODELS (CONTINUED)

**MAP
APPLIES**

FULLY ASSEMBLED, COMMERCIAL GRADE, CERTIFIED INSERTS

All fire pit inserts come fully assembled and include installation and operation instructions.

LINEAR INTERLINK PAN INSERTS

EI MODELS INCLUDE:

Insert: Fully Assembled

Flex Line: Gas Input

Instructions

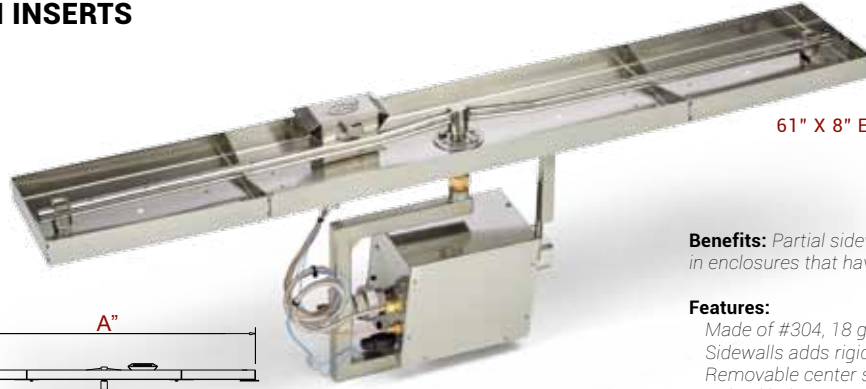

61" X 8" Electronic Ignition (EI)

Benefits: Partial sidewall for media retention; used in enclosures that have recess mount of insert.

Features:

- Made of #304, 18 gauge Stainless Steel
- Sidewalls adds rigidity- stronger than flat pans
- Removable center section on larger models
- Raised hub T-Burner for water prevention
- Secure gas fitting for strength
- Weep holes for drainage

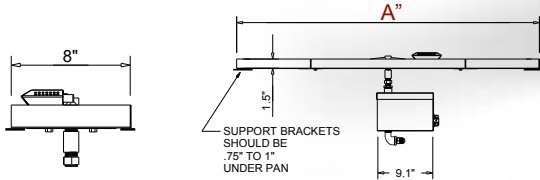

Accessories (Pg. 26):

- Timers
- Power Supplies
- E-Stop



SOLD SEPARATELY:

On/Off Models 120VAC- Remote: 578-C: See Pg. 26

Vinyl Cover: See Chart on Pg. 65

Lava Rock / Glass: See Chart on Pg. 65



**See Pg. 8 for
EI System Features**

Electronic Ignition Models - EI Series Specifications

Size (A")	Power	Gas type	Model - Flame ON/OFF	Model - Flame Adjustment (HI/LO)	Burner	Max BTU
				HI/LO MODELS COME WITH REMOTE (this column only)		
25" X 8"	120vac	Natural Gas	25X8SSEI-L-NG/120VAC	25X8SSEI-L-HI/LO-NG/120VAC	24" T-Burner	50k
		Liquid Propane	25X8SSEI-L-LP/120VAC	25X8SSEI-L-HI/LO-LP/120VAC		
	24vac	Natural Gas	25X8SSEI-L-NG/24VAC	25X8SSEI-L-HI/LO-NG/24VAC		
		Liquid Propane	25X8SSEI-L-LP/24VAC	25X8SSEI-L-HI/LO-LP/24VAC		
37" X 8"	120vac	Natural Gas	37X8SSEI-L-NG/120VAC	37X8SSEI-L-HI/LO-NG/120VAC	36" T-Burner	75k
		Liquid Propane	37X8SSEI-L-LP/120VAC	37X8SSEI-L-HI/LO-LP/120VAC		
	24vac	Natural Gas	37X8SSEI-L-NG/24VAC	37X8SSEI-L-HI/LO-NG/24VAC		
		Liquid Propane	37X8SSEI-L-LP/24VAC	37X8SSEI-L-HI/LO-LP/24VAC		
49" X 8"	120vac	Natural Gas	49X8SSEI-L-NG/120VAC	49X8SSEI-L-HI/LO-NG/120VAC	48" T-Burner	100k
		Liquid Propane	49X8SSEI-L-LP/120VAC	49X8SSEI-L-HI/LO-LP/120VAC		
	24vac	Natural Gas	49X8SSEI-L-NG/24VAC	49X8SSEI-L-HI/LO-NG/24VAC		
		Liquid Propane	49X8SSEI-L-LP/24VAC	49X8SSEI-L-HI/LO-LP/24VAC		
61" X 8"	120vac	Natural Gas	61X8SSEI-L-NG/120VAC	61X8SSEI-L-HI/LO-NG/120VAC	60" T-Burner	125k
		Liquid Propane	61X8SSEI-L-LP/120VAC	61X8SSEI-L-HI/LO-LP/120VAC		
	24vac	Natural Gas	61X8SSEI-L-NG/24VAC	61X8SSEI-L-HI/LO-NG/24VAC		
		Liquid Propane	61X8SSEI-L-LP/24VAC	61X8SSEI-L-HI/LO-LP/24VAC		
73 X 8"	120vac	Natural Gas	73X8SSEI-L-NG/120VAC	73X8SSEI-L-HI/LO-NG/120VAC	72" T-Burner	150k
		Liquid Propane	73X8SSEI-L-LP/120VAC	73X8SSEI-L-HI/LO-LP/120VAC		
	24vac	Natural Gas	73X8SSEI-L-NG/24VAC	73X8SSEI-L-HI/LO-NG/24VAC		
		Liquid Propane	73X8SSEI-L-LP/24VAC	73X8SSEI-L-HI/LO-LP/24VAC		
97 X 8"	120vac	Natural Gas	97X8SSEI-L-NG/120VAC	97X8SSEI-L-HI/LO-NG/120VAC	96" T-Burner	200k
		Liquid Propane	97X8SSEI-L-LP/120VAC	97X8SSEI-L-HI/LO-LP/120VAC		
	24vac	Natural Gas	97X8SSEI-L-NG/24VAC	97X8SSEI-L-HI/LO-NG/24VAC		
		Liquid Propane	97X8SSEI-L-LP/24VAC	97X8SSEI-L-HI/LO-LP/24VAC		
121 X 8"	120vac	Natural Gas	121X8SSEI-L-NG/120VAC	121X8SSEI-L-HI/LO-NG/120VAC	120" T-Burner	250k
		Liquid Propane	121X8SSEI-L-LP/120VAC	121X8SSEI-L-HI/LO-LP/120VAC		
	24vac	Natural Gas	121X8SSEI-L-NG/24VAC	121X8SSEI-L-HI/LO-NG/24VAC		
		Liquid Propane	121X8SSEI-L-LP/24VAC	121X8SSEI-L-HI/LO-LP/24VAC		

Match proper accessories to your fire pit model - see Pg. 65-68.

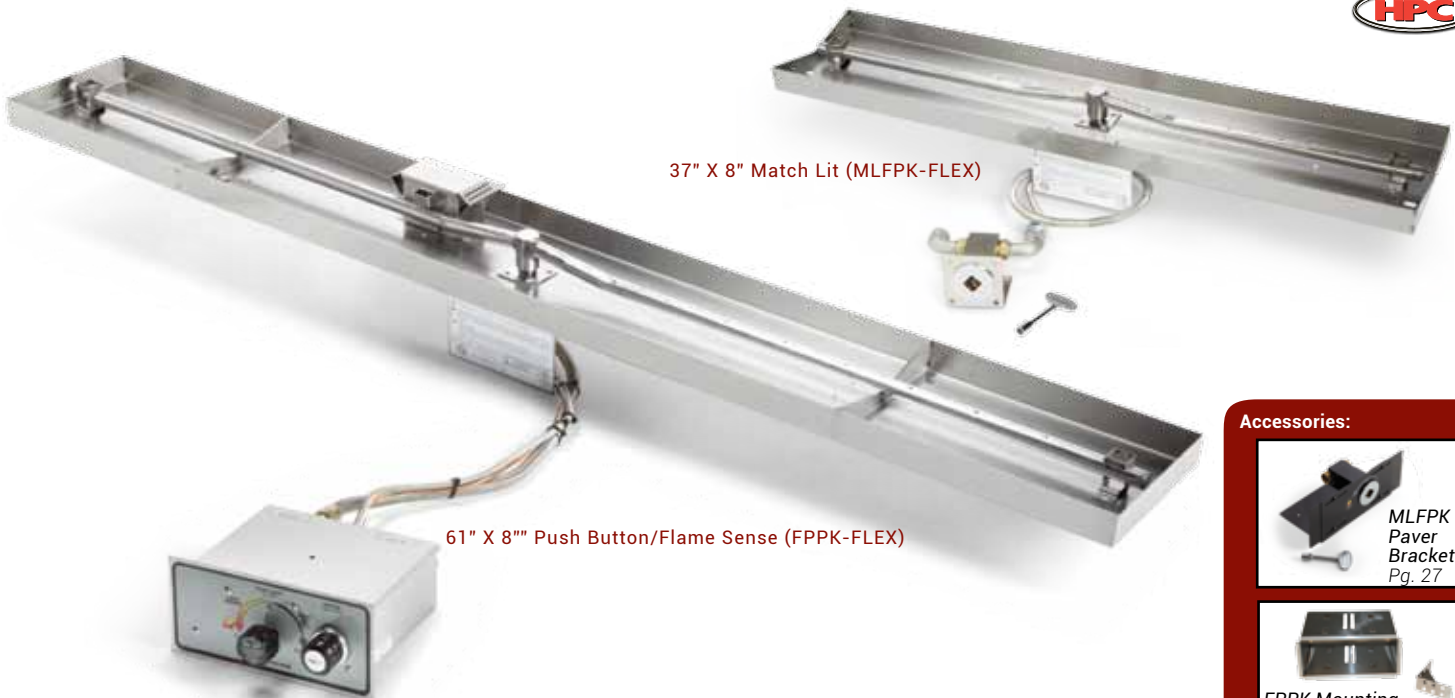

37" X 8" Match Lit (MLFPK-FLEX)

61" X 8" Push Button/Flame Sense (FPPK-FLEX)

Accessories:



Media Pg. 46
Outdoor Logs Pg. 48
Hard Covers Pg. 49



SOLD SEPARATELY:

Input Flex Line: SSC-HC24: All models
Vinyl Cover: See Chart on Pg. 67
Lava Rock / Glass: See Chart on Pg. 67

FPPK & MLFPK MODELS INCLUDE:

Insert: Fully Assembled
Instructions

Push Button/Flame Sense Models - FPPK Flex Series Specifications

See Pg. 9 for FPPK System Features

Size	Gas type	Model	Burner	Max BTU	* Flex Line
25" X 8"	Natural Gas	FPPK25X8-L-FLEX-NG	24" T-Burner	50k	36"
	Liquid Propane	FPPK25X8-L-FLEX-LP			
37" X 8"	Natural Gas	FPPK37X8-L-FLEX-NG	36" T-Burner	75k	36"
	Liquid Propane	FPPK37X8-L-FLEX-LP			
49" X 8"	Natural Gas	FPPK49X8-L-FLEX-NG	48" T-Burner	90k	36"
	Liquid Propane	FPPK49X8-L-FLEX-LP			
61" X 8"	Natural Gas	FPPK61X8-L-FLEX-NG	60" T-Burner	125k	36"
	Liquid Propane	FPPK61X8-L-FLEX-LP			
73" X 8"	Natural Gas	FPPK73X8-L-FLEX-NG	72" T-Burner	140k	36"
	Liquid Propane	FPPK73X8-L-FLEX-LP			
97" X 8"	Natural Gas	FPPK97X8-L-FLEX-NG	96" T-Burner	140k	36"
	Liquid Propane	FPPK97X8-L-FLEX-LP			

LP Small Tank - CSA Certified for use. (See Pg.27)

*Between valve and burner



SOLD SEPARATELY:

Input Flex Line: SSC24: All models
Vinyl Cover: See Chart on Pg. 68
Lava Rock / Glass: See Chart on Pg. 68

Match Lit Models - MLFPK Flex Series Specifications

See Pg. 10 for MLFPK System Features

Size	Gas type	Model	Burner	Max BTU	* Flex Line
25" X 8"	Natural Gas	MLFPK25X8-L-FLEX-NG	24" T-Burner	50k	36"
	Liquid Propane	MLFPK25X8-L-FLEX-LP			
37" X 8"	Natural Gas	MLFPK37X8-L-FLEX-NG	36" T-Burner	65k	36"
	Liquid Propane	MLFPK37X8-L-FLEX-LP			
49" X 8"	Natural Gas	MLFPK49X8-L-FLEX-NG	48" T-Burner	65k	36"
	Liquid Propane	MLFPK49X8-L-FLEX-LP			

LP Small Tank - CSA Certified for use. (See Pg.27)

*Between valve and burner

CONTROL OPTIONS

ELECTRONIC IGNITION MODELS (EI)

COMMERCIAL AUTOMATIC SHUTOFF TIMERS - 120VAC



694

Stainless Steel Rotary Timer (SPDT, 20A)
2 Hour Timer. 1/2" deep.
Double gang box recommended.
For use with NEMA 3R box for mounting enclosure (not provided)



695

Stainless Steel Rotary Timer (SPDT, 20A)
12 Hour Timer. 1/2" deep.
Double gang box recommended.
For use with NEMA 3R box for mounting enclosure (not provided)



696

Four preset switch for indoors.
Can be set at 2, 4, 8, and 12 hours (SPDT, 20A)
Fits single Gangbox

POWER SUPPLIES - FOR 24VAC MODELS

Input Primary - 120VAC, 60/50Hz, 1A max
Output Secondary - 24VAC, 60/50Hz, 4A



Model	Style
311-PS1	1 Output
311-PS3	3 Outputs
311-PS5	5 Outputs

COMMERCIAL EMERGENCY STOP - 120VAC OR 24VAC

Perfect for commercial applications of Evolution 360 or EI systems. Push button with keyed reset allows supervisor confirmation. Safely turns off up to 3 circuits plus one fail safe function.



For replacement Keys use product number:
E-STOP-KEY

311-ESTOP-3

Size: 2.8" x 2.8" x 4", Rated for 600VA, 10A
Rated IP65 - Protection against dust and low pressure water from all directions.

120 VAC OUTDOOR ON/OFF REMOTE CONTROL



578-C

Used with EI Fire Pit Systems. 120 VAC models only. CARLON in-line power control with 3 prong in/out.

DECK INSULATION KIT (EI, FPPK & MLFPK)

This kit is for use when installing a gas fire pit on a wood or composite deck- provides flame and excess heat protection around input flex line connection(s). This basalt insulation is for inside the fire pit enclosure or bowl, is meant to place over a layer of paver blocks (1" min. thickness) commonly found at your local builder's store. Incoming gas stub must protrude through the deck, paver blocks and insulation for fire pit flex line connection. Kit includes basalt insulation and instructions- basalt insulation measures 39.3" x 39.3" (1 sq. meter)- larger fire pits will require more pieces, insulation is easily cut with utility knife. Smaller bowl kit available.

FPI-DECK20SQ - For fire bowls includes basalt insulation- 19.6" x 19.6"

FPI-DECK39SQ - For fire pits- includes basalt insulation- 39.3" x 39.3" (1 sq. meter).

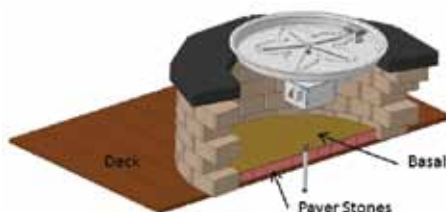

PUSH BUTTON / FLAME SENSE MODELS (FPPK)



FPPK CONTROL BOX MOUNTING SLEEVE

This stainless steel sleeve can be mortared in place with block or fastened to stone or metal - adjustable support bracket included. (7.75"W x 3.25"H x 6.25"D)

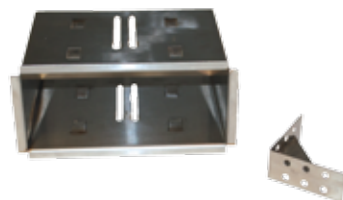

FPPK-VBMS

MATCH LIT MODELS (MLFPK)

PAVER BLOCK BRACKET

Designed for the Dante Valve, this bracket allows flexibility and installation ease of the MLFPK decorative key valve. The face plate is adjustable from 8" to 12" width accommodating most pavers. The valve is securely mounted to bracket using decorative flange. (8-12"W x 3.875H x 5"D)

IMPORTANT: For use only with DANTE Valve #327-CH (Pg. 60)



*Valve/Flange
Key not included

KVMB-PB

SMALL TANK KIT - LP (FPPK & MLFPK)

This kit is for use with CSA certified FPPK, MLFPK, and FPK fire pit models less than 90k Btu- see fire pit insert section for approved models. The kits includes a 90-degree regulator with 48" hose, 24" Flex Line, small tank L-Bracket and fittings for FPPK or MLFPK connection.

For use with CSA Certified FPPK & MLFPK fire pit inserts only



STLPK









READY TO FINISH SERIES

COMPLETE FIRE PIT PACKAGES

HPC offers complete fire pit packages that include unfinished enclosures fitted with a certified remote electronic ignition (EI), push button/flame sense (FPPK) or match lit (MLFPK) fire pit insert.

MAP APPLIES

READY TO FINISH

These units are unfinished to allow the customer to finish with stone, veneer, or stucco to match their surrounding. Units are available in round, octagon, square, and linear shapes. Housings take the guess work out of enclosure construction - especially with the difficult round and octagon shapes. These are 18" tall and are constructed of sturdy 22 gauge galvanized steel material, welded frame, and a 1/2" hardboard shell, and weigh 150 lbs.

Enclosure ships from North Carolina Warehouse on pallet; Fire Pit ships from Ohio Warehouse.

ROUND ENCLOSURE

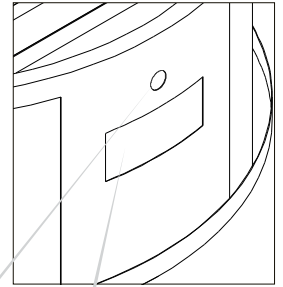

Frame is pre-cut for FPPK or MLFPK but NOT hardboard.

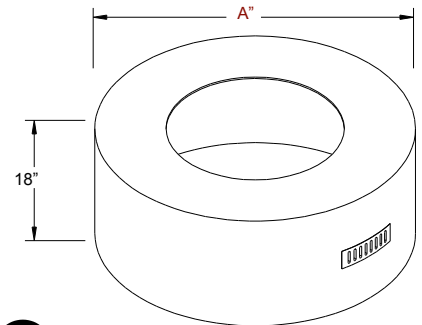

EI Models Include: Enclosure, Fully Assembled Insert, Input Flex Line and Instructions







FPPK Models Include: Enclosure, Fully Assembled Insert, Mounting Sleeve and Instructions

MLFPK Models Include: Enclosure, Fully Assembled Insert and Instructions



Size: 45" or 54" diameter, 18" tall
Insert: 25" Bowl Pan, 18" Penta Burner

Specifications

Ignition	Size (A")	Power	Gas type	Model	Max BTU	Insert		
Electronic Ignition 	45"	120VAC	Natural Gas	U45R/25SSCEK-NG/120VAC	125k	 Pg. 12		
		24VAC	Natural Gas	U45R/25SSCEK-LP/120VAC				
	54"	120VAC	Natural Gas	U54R/25SSCEK-NG/120VAC	125k			
		24VAC	Natural Gas	U54R/25SSCEK-LP/120VAC				
	Push Button- Flame Sense 	45"	120VAC	Natural Gas	U45R/FPPK25CEK-NG		90k	 Pg. 13
			24VAC	Natural Gas	U45R/FPPK25CEK-LP			
54"		120VAC	Natural Gas	U54R/FPPK25CEK-NG	90k			
		24VAC	Natural Gas	U54R/FPPK25CEK-LP				
Match Lit 	45"	120VAC	Natural Gas	U45R/MLFPK25CEK-NG	65k	 Pg. 13		
		24VAC	Natural Gas	U45R/MLFPK25CEK-LP				
	54"	120VAC	Natural Gas	U54R/MLFPK25CEK-NG	65k			
		24VAC	Natural Gas	U54R/MLFPK25CEK-LP				

 Need help? Use our fire pit selector at hpcfire.com

READY TO FINISH SERIES (CONTINUED)

MAP APPLIES

COMPLETE FIRE PIT PACKAGES

HPC offers complete fire pit packages that include unfinished enclosures fitted with a certified remote electronic ignition (EI), push button/flame sense (FPPK) or match lit (MLFPK) fire pit insert.

READY TO FINISH

These units are unfinished to allow the customer to finish with stone, veneer, or stucco to match their surrounding. Units are available in round, octagon, square, and linear shapes. Housings take the guess work out of enclosure construction - especially with the difficult round and octagon shapes. These are 18" tall and are constructed of sturdy 22 gauge galvanized steel material, welded frame, and a 1/2" hardboard shell, and weigh 150 lbs.

Enclosure ships from North Carolina Warehouse on pallet; Fire Pit ships from Ohio Warehouse.

OCTAGON ENCLOSURE

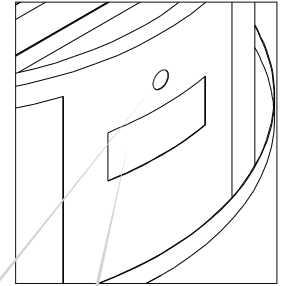

Frame is pre-cut for FPPK or MLFPK but NOT hardboard.

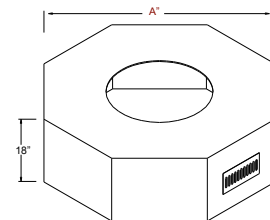

EI Models Include: Enclosure, Fully Assembled Insert, Input Flex Line and Instructions







FPPK Models Include: Enclosure, Fully Assembled Insert, Mounting Sleeve and Instructions

MLFPK Models Include: Enclosure, Fully Assembled Insert and Instructions



Size: 45" or 54" diameter, 18" tall
Insert: 25" Bowl Pan, 18" Penta Burner

Specifications

Ignition	Size (A")	Power	Gas type	Model	Max BTU	Insert
	45"	120VAC	Natural Gas	U450/25SSCEK-NG/120VAC	125k	
		24VAC	Natural Gas	U450/25SSCEK-NG/24VAC		
	54"	120VAC	Natural Gas	U540/25SSCEK-NG/120VAC	125k	
		24VAC	Natural Gas	U540/25SSCEK-NG/24VAC		
	45"		Natural Gas	U450/FPPK25CEK-NG	90k	
	54"		Natural Gas	U540/FPPK25CEK-NG	90k	
			Liquid Propane	U540/FPPK25CEK-LP		
	45"		Natural Gas	U450/MLFPK25CEK-NG	65k	
	54"		Natural Gas	U540/MLFPK25CEK-NG	65k	
			Liquid Propane	U540/MLFPK25CEK-LP		

Pg. 12

Pg. 13

Pg. 13



Two Ready to Finish inserts take this hot tub to the next level.

Photo Courtesy of SE Design & Construction - Pennsylvania

RECTANGLE BURNER ENCLOSURE - INTERLINK BURNER INSERT

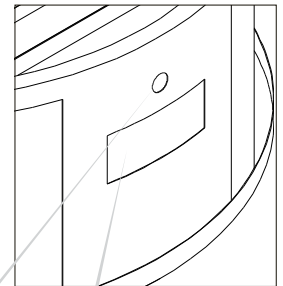

Frame is pre-cut for FPPK or MLFPK but NOT hardboard.

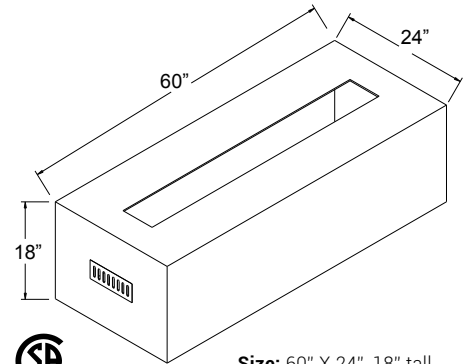







Size: 60" X 24", 18" tall
Insert: 37" X 8" or 49" X 8"

EI Models Include: Enclosure, Fully Assembled Insert, Input Flex Line and Instructions

FPPK Models Include: Enclosure, Fully Assembled Insert, Mounting Sleeve and Instructions

MLFPK Models Include: Enclosure, Fully Assembled Insert and Instructions

Specifications

Ignition	Insert	Power	Gas type	Model	Max BTU	Insert
Electronic Ignition 	37" X 8"	120VAC	Natural Gas Liquid Propane	U60X24/37X8CEK-NG/120VAC U60X24/37X8CEK-LP/120VAC	75k	 Pg. 24
		24VAC	Natural Gas Liquid Propane	U60X24/37X8CEK-NG/24VAC U60X24/37X8CEK-LP/24VAC		
	49" X 8"	120VAC	Natural Gas Liquid Propane	U60X24/49X8CEK-NG/120VAC U60X24/49X8CEK-LP/120VAC	100k	
		24VAC	Natural Gas Liquid Propane	U60X24/49X8CEK-NG/24VAC U60X24/49X8CEK-LP/24VAC		
Push Button-Flame Sense 	37" X 8"		Natural Gas Liquid Propane	U60X24/37X8FPPKCEK-NG U60X24/37X8FPPKCEK-LP	75k	 Pg. 25
	49" X 8"		Natural Gas Liquid Propane	U60X24/49X8FPPKCEK-NG U60X24/49X8FPPKCEK-LP	90k	
Match Lit 	37" X 8"		Natural Gas Liquid Propane	U60X24/37X8MLFPKCEK-NG U60X24/37X8MLFPKCEK-LP	65k	 Pg. 25
	49" X 8"		Natural Gas Liquid Propane	U60X24/49X8MLFPKCEK-NG U60X24/49X8MLFPKCEK-LP	65k	

READY TO FINISH SERIES (CONTINUED)

MAP APPLIES

COMPLETE FIRE PIT PACKAGES

HPC offers complete fire pit packages that include unfinished enclosures fitted with a certified remote electronic ignition (EI), push button/flame sense (FPPK) or match lit (MLFPK) fire pit insert.

READY TO FINISH

These units are unfinished to allow the customer to finish with stone, veneer, or stucco to match their surrounding. Units are available in round, octagon, square, and linear shapes. Housings take the guess work out of enclosure construction - especially with the difficult round and octagon shapes. These are 18" tall and are constructed of sturdy 22 gauge galvanized steel material, welded frame, and a 1/2" hardiboard shell, and weigh 150 lbs.

Enclosure ships from North Carolina Warehouse on pallet; Fire Pit ships from Ohio Warehouse.

RECTANGLE BURNER ENCLOSURE - TROUGH BURNER INSERT

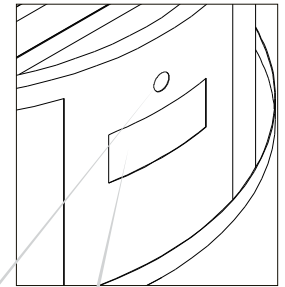

Frame is pre-cut for FPPK or MLFPK but NOT hardiboard.

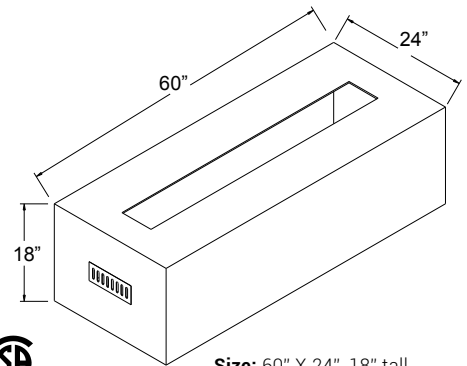

Size: 60" X 24", 18" tall
Insert: 36" or 48" Trough







EI Models Include: Enclosure, Fully Assembled Insert, Input Flex Line and Instructions

FPPK Models Include: Enclosure, Fully Assembled Insert, Mounting Sleeve and Instructions

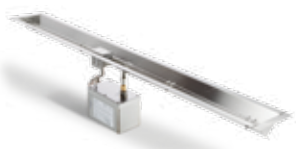
MLFPK Models Include: Enclosure, Fully Assembled Insert and Instructions

Specifications

Ignition	Insert	Power	Gas type	Model	Max BTU	Insert
	36" Trough	120VAC	Natural Gas	U60X24/36CEK-NG/120VAC	75k	
			Liquid Propane	U60X24/36CEK-LP/120VAC		
	24VAC	Natural Gas	U60X24/36CEK-NG/24VAC	100k		
		Liquid Propane	U60X24/36CEK-LP/24VAC			
	48" Trough	120VAC	Natural Gas	U60X24/48CEK-NG/120VAC	90k	
			Liquid Propane	U60X24/48CEK-LP/120VAC		
	24VAC	Natural Gas	U60X24/48CEK-NG/24VAC	65k		
		Liquid Propane	U60X24/48CEK-LP/24VAC			
	36" Trough		Natural Gas	U60X24/36MLFPKCEK-NG	65k	
			Liquid Propane	U60X24/36MLFPKCEK-LP		
	48" Trough		Natural Gas	U60X24/48MLFPKCEK-NG	65k	
			Liquid Propane	U60X24/48MLFPKCEK-LP		

Pg. 22

Pg. 23

Pg. 23



Finished Enclosure in this beautiful backyard escape is guaranteed to take your breath away.

Photo Courtesy of The Hearth Shop - California

RECTANGLE BURNER ENCLOSURE - H-BURNER INSERT

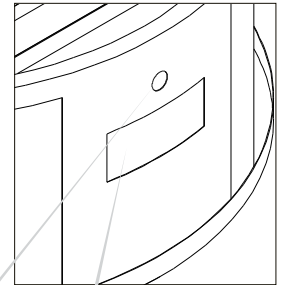

Frame is pre-cut for FPPK or MLFPK but NOT hardboard.

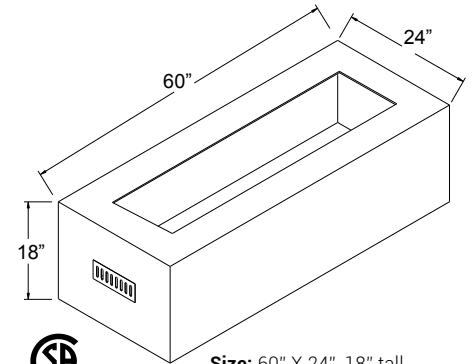







Size: 60" X 24", 18" tall
Insert: 30" X 12" or 36" X 14"

EI Models Include: Enclosure, Fully Assembled Insert, Input Flex Line and Instructions

FPPK Models Include: Enclosure, Fully Assembled Insert, Mounting Sleeve and Instructions

MLFPK Models Include: Enclosure, Fully Assembled Insert and Instructions

Specifications

Ignition	Insert	Power	Gas type	Model	Max BTU	Insert
Electronic Ignition 	30" X 12"	120VAC	Natural Gas Liquid Propane	U60X24/30X12CEK-NG/120VAC U60X24/30X12CEK-LP/120VAC	100k	 Pg. 18
		24VAC	Natural Gas Liquid Propane	U60X24/30X12CEK-NG/24VAC U60X24/30X12CEK-LP/24VAC		
	36" X 14"	120VAC	Natural Gas Liquid Propane	U60X24/36X14CEK-NG/120VAC U60X24/36X14CEK-LP/120VAC	125k	
		24VAC	Natural Gas Liquid Propane	U60X24/36X14CEK-NG/24VAC U60X24/36X14CEK-LP/24VAC		
Push Button- Flame Sense 	30" X 12"		Natural Gas Liquid Propane	U60X24/30X12FPPKCEK-NG U60X24/30X12FPPKCEK-LP	90k	 Pg. 19
	36" X 14"		Natural Gas Liquid Propane	U60X24/36X14FPPKCEK-NG U60X24/36X14FPPKCEK-LP	90k	
Match Lit 	30" X 12"		Natural Gas Liquid Propane	U60X24/30X12MLFPKCEK-NG U60X24/30X12MLFPKCEK-LP	65k	 Pg. 19
	36" X 14"		Natural Gas Liquid Propane	U60X24/36X14MLFPKCEK-NG U60X24/36X14MLFPKCEK-LP	65k	

READY TO FINISH SERIES (CONTINUED)

MAP APPLIES

COMPLETE FIRE PIT PACKAGES

HPC offers complete fire pit packages that include unfinished enclosures fitted with a certified remote electronic ignition (EI), push button/flame sense (FPPK) or match lit (MLFPK) fire pit insert.

RECTANGLE BURNER ENCLOSURE - S-FIRE BURNER INSERT

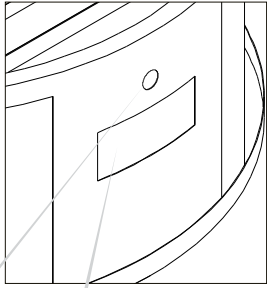

Frame is pre-cut for FPPK or MLFPK but NOT hardiboard.

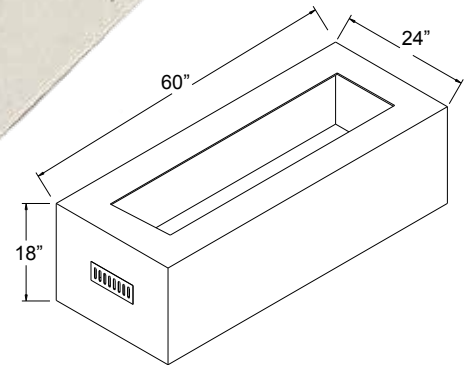

Available June 2017

EI Models Include: Enclosure, Fully Assembled Insert, Input Flex Line and Instructions







FPPK Models Include: Enclosure, Fully Assembled Insert, Mounting Sleeve and Instructions

MLFPK Models Include: Enclosure, Fully Assembled Insert and Instructions



Size: 60" X 24", 18" tall
Insert: 36" X 14"

Specifications

Ignition	Size	Power	Gas type	Model	Max BTU	Insert
 Electronic Ignition	60x24x18"	120VAC	Natural Gas	U60X24/SFIRECEK-NG/120VAC	75k	 Pg. 20
		24VAC	Natural Gas	U60X24/SFIRECEK-NG/24VAC		
 Push Button	60x24x18"		Natural Gas	U60X24/SFIREFPPKCEK-NG	75k	 Pg. 21
			Liquid Propane	U60X24/SFIREFPPKCEK-LP		
 Match Lit	60x24x18"		Natural Gas	U60X24/SFIREMLFPKCEK-NG	65k	 Pg. 21
			Liquid Propane	U60X24/SFIREMLFPKCEK-LP		



This Enclosure turns this backyard patio into an outdoor room with our Deck Installation Kit (Pg. 26).

Photo Courtesy of Blue Flame Specialties - Oregon

SQUARE BURNER ENCLOSURE

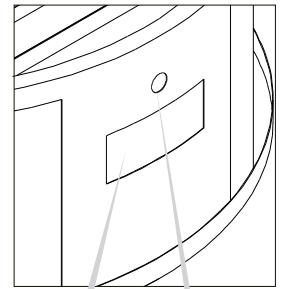

Frame is pre-cut for FPPK or MLFPK but NOT hardboard.

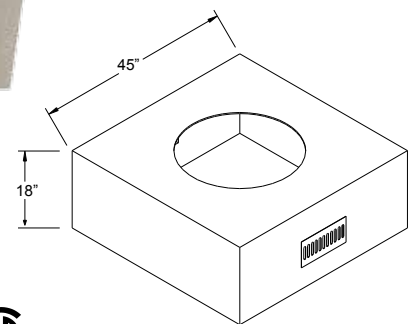

EI Models Include: Enclosure, Fully Assembled Insert, Input Flex Line and Instructions

FPPK Models Include: Enclosure, Fully Assembled Insert, Mounting Sleeve and Instructions

MLFPK Models Include: Enclosure, Fully Assembled Insert and Instructions



Size: 45" X 45", 18" tall
Insert: 25" Bowl Pan, 18" Penta Burner

Specifications

Ignition	Size (A")	Power	Gas type	Model	Max BTU	Insert
Electronic Ignition 	45"	120VAC	Natural Gas Liquid Propane	U45S/25SSCEK-NG/120VAC U45S/25SSCEK-LP/120VAC	125k	 Pg. 12
		24VAC	Natural Gas Liquid Propane	U45S/25SSCEK-NG/24VAC U45S/25SSCEK-LP/24VAC		
Push Button 	45"		Natural Gas Liquid Propane	U45S/FPPK25CEK-NG U45S/FPPK25CEK-LP	90k	 Pg. 13
Match Lit 	45"		Natural Gas Liquid Propane	U45S/MLFPK25CEK-NG U45S/MLFPK25CEK-LP	65k	 Pg. 13

COPPER BOWL SERIES

COMPLETE FIRE PIT PACKAGES

The HPC Copper Bowl Series is available in the Fire Bowl or the Pool Side Fire & Water Bowl models. Both versions are fitted with a CSA Certified match lit (MLFPK) or remote electronic ignition (EI) fire pit insert and are available with both Liquid Propane and Natural Gas. These come in an oil rubbed look with either a hammered finish or a smooth finish, based on model. The Pool Side Fire & Water Bowls utilize 1" FIP fitting for pool pump connection.

SHIPPING: Both bowl and fire pit insert ship from Ohio warehouse - crate on pallet.



Mesa Fire Bowl

Mesa Fire & Water Bowl

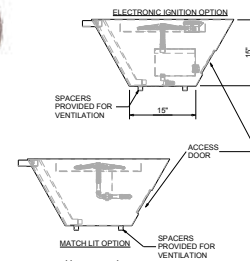

MESA MODELS - HAMMERED

This round hammered bowl has an oil-rubbed look. Includes Access Door.



Size: 32" diameter, 15" tall, 15" base
Burner: 12" Penta **Pan:** 18" Flat

Specifications

Ignition	Bowl Type	Power	Gas type	Models	Max BTU
Electronic Ignition 	Fire	120vac	Natural Gas	MESA32-EI-NG/120VAC	50k
	Fire	24vac	Natural Gas	MESA32-EI-NG/24VAC	50k
	Fire & Water	24vac	Natural Gas	MESA32W-EI-NG/24VAC	50k
Match Lit 	Fire		Natural Gas	MESA32-MLFPK-NG	50k
	Fire		Liquid Propane	MESA32-MLFPK-LP	
	Fire & Water		Natural Gas	MESA32W-MLFPK-NG	50k
	Fire & Water		Liquid Propane	MESA32W-MLFPK-LP	



Sierra Fire Bowl

Sierra Fire & Water Bowl

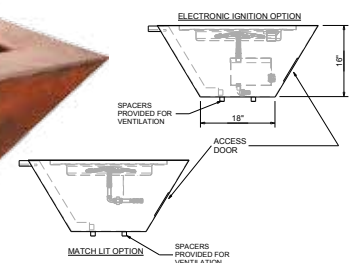

SIERRA MODELS - SMOOTH

This square smooth bowl has an oil-rubbed look. Includes Access Door.



Size: 36" x 36", 16" tall, 18" x 18" base
Burner: 12" Penta
Pan: 19" Bowl

Specifications

Ignition	Bowl Type	Power	Gas type	Models	Max BTU
Electronic Ignition 	Fire	120vac	Natural Gas	SIER36-EI-NG/120VAC	50k
	Fire	24vac	Natural Gas	SIER36-EI-NG/24VAC	50k
	Fire & Water	24vac	Natural Gas	SIER36W-EI-NG/24VAC	50k
Match Lit 	Fire		Natural Gas	SIER36-MLFPK-NG	50k
	Fire		Liquid Propane	SIER36-MLFPK-LP	
	Fire & Water		Natural Gas	SIER36W-MLFPK-NG	50k
	Fire & Water		Liquid Propane	SIER36W-MLFPK-LP	



Copper Cleaning Kit (CCK)
Cleaning kit includes bee's wax,
sandpaper and steel wool.



Sedona Fire Bowl

Sedona Fire & Water Bowl

SEDONA MODELS - HAMMERED

This square hammered bowl has an oil rubbed look.
Includes Access Door.

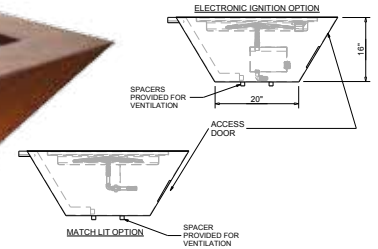

Size: 40" x 40", 16" tall, 20" x 20" base
Burner: 18" Penta **Pan:** 25" Bowl

Specifications

Ignition	Bowl Type	Power	Gas type	Models	Max BTU
	Fire	120vac	Natural Gas Liquid Propane	SEDO40-EI-NG/120VAC SEDO40-EI-LP/120VAC	100k
	Fire	24vac	Natural Gas Liquid Propane	SEDO40-EI-NG/24VAC SEDO40-EI-LP/24VAC	100k
	Fire & Water	24vac	Natural Gas Liquid Propane	SEDO40W-EI-NG/24VAC SEDO40W-EI-LP/24VAC	100k
	Fire		Natural Gas Liquid Propane	SEDO40-MLFPK-NG SEDO40-MLFPK-LP	65k
	Fire & Water		Natural Gas Liquid Propane	SEDO40W-MLFPK-NG SEDO40W-MLFPK-LP	65k



Tempe Fire Bowl

Tempe Fire & Water Bowl

TEMPE MODELS - HAMMERED

This round hammered bowl has an oil rubbed look.
Controls sit below bowl.

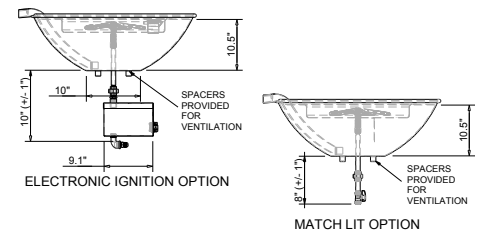

Tempe - Controls below bowl

Size: 31" diameter, 10.5" tall, 10" base
Burner: 12" Penta **Pan:** 19" Bowl

Specifications

Ignition	Bowl Type	Power	Gas type	Models	Max BTU
	Fire	120vac	Natural Gas Liquid Propane	TEMP31-EI-NG/120VAC TEMP31-EI-LP/120VAC	50k
	Fire	24vac	Natural Gas Liquid Propane	TEMP31-EI-NG/24VAC TEMP31-EI-LP/24VAC	50k
	Fire & Water	24vac	Natural Gas Liquid Propane	TEMP31W-EI-NG/24VAC TEMP31W-EI-LP/24VAC	50k
	Fire		Natural Gas Liquid Propane	TEMP31-MLFPK-NG TEMP31-MLFPK-LP	50k
	Fire & Water		Natural Gas Liquid Propane	TEMP31W-MLFPK-NG TEMP31W-MLFPK-LP	50k

WATER FEATURE INSERTS



MAP
APPLIES

EVOLUTION 360 - H2Onfire

Perfect for any residential or commercial setting, these innovative fire and water effects add the sound of soothing water and beautiful blue LED lights to the warmth and romance of fire. They arrive fully assembled with a self-contained filtrated water system and wall switch control of fire, water, and lights. Just level the basin and connect the water, electric, and gas.

These features can be installed on practically any patio in a residential or commercial setting - no pond or pool needed! This fully assembled, plug-n-play system comes ready to install - simply level the water pit then connect water, electric, and gas. Finally, enclose with stone, veneer, stucco, etc. to match your patio décor. Operation is even simpler - three switches control the water, LED lights, and fire pit. The Evolution 360 is made of durable, weather resistant, black polyethylene and engineered to last - no on-site guesswork. **Ships in crate on pallet.**

EVOLUTION 360 AND H2Onfire FEATURES



Evolution 360 Model



Beautiful LED Lighting



Low Level Sensor



Auto-fill - Overflow

Swim World Pools - TN ▲

IBS Show Las Vegas



H2Onfire Model



Water Filter



Flow Control Valve



Control Box

Features:

- Beautiful blue LED lights to illuminate water** - hidden under scupper.
- Auto fill system** - automatically adds water when needed; Low level sensor protects pump if water supply issue
- Filtration** - water is conditioned with a reusable, easy-to-clean filter
- Water pump** - 2,400 to 4,800 gallons per-hour depending on model

Leveling / Height Setting - four heavy, 3/4" threaded feet give flexibility of height adjustment and leveling. Easily adjusted on site with ~4" of travel

Overflow feature - allows water to escape safely

Electrical Connection - simply with a 5-lead, 10' cable ready to connect. Control Panel incorporates 3 push-to-reset breakers for water, LEDs & fire

EVOLUTION 360 AND H20nfire INFORMATION

Basin Dimensions

Outside Diameter: 52"
Overall Height: 26" - 30"
Basin: 14"-18" with Adjustable Side Wall Height
Tower: 10" Diameter Flange to Mount Centerpiece

Basin Weight

125 lbs Dry, 532 lbs Wet

Additional Load

Basin floor: 200 lbs max
Tower: 100 lbs max

Water

Softened tap water only - Minor conditioning needed
Capacity: Unit holds 50 Gallons (less with Water Rock)
Water Pump: 3,200gph Standard (higher rates available)

Power

120VAC - Control via panel or from remote location.



EVOLUTION 360 - FIRE AND WATER INSERTS MAP

HPC'S AWARD WINNING - VERY POPULAR FIRE AND WATER ELEMENT APPLIES

These insert's have many unique and user friendly features that make it a year round water and fire pit. We have made these inserts so the fire, water and lighting features will work independently of each other making it an ideal insert in areas that need to winterize the water feature but still enjoy their landscape.

HAMMERED COPPER FIRE BOWL

Hammered Copper - 4 Scupper



Four Scupper Feature



Hammered Copper - 360

360 Feature



360 Feature being finished with paver stone

Includes Basin, 26" Copper Water Bowl, and Electronic Ignition Fire Pit (13SSEI).

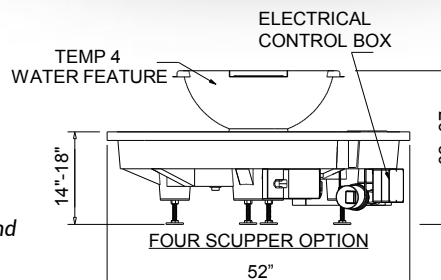

Winner of two Vesta Awards for Product Innovation and Design

Size: 52" diameter, 14"-18" tall
Burner: 12" Round

Specifications - Electronic Ignition

Bowl Type	Power	Gas type	Models (EI)	Max BTU
4 Scupper	120vac	Natural Gas	WB52R-TEMP4-EI-NG	90k
		Liquid Propane	WB52R-TEMP4-EI-LP	
360	120vac	Natural Gas	WB52R-TEMP360-EI-NG	90k
		Liquid Propane	WB52R-TEMP360-EI-LP	



H2Onfire - FIRE ON WATER INSERTS

MAP
APPLIES

HPC'S AWARD WINNING - VERY POPULAR FIRE AND WATER ELEMENT

HPC is proud to announce another first in the industry as well as adding a new element to the water feature insert series, the H2Onfire fire on water feature. This insert has been a longtime request of our dealers (and the consumer). A true electronic fire on water, turn-key appliance operating at a gas pressure of only 1/2 psi, allowing for residential installations. It is also the first "fire on water" system to be certified in North America to the Z21.97 standard by the CSA Group - passing the stringent wind, rain, and combustion test.

The fire ring is totally submerged underwater using our patent pending burner design and back flow prevention to protect the controls - giving an even and very appealing flame at only 65,000 Btu. This is NOT a match lit system- it is remote control with auto relight. Our ignition and flame sensing network is located in the center tower monitoring flame conditions at all times.
Ships in crate on pallet.

CONCRETE FIRE ON WATER AND HAMMERED COPPER 360

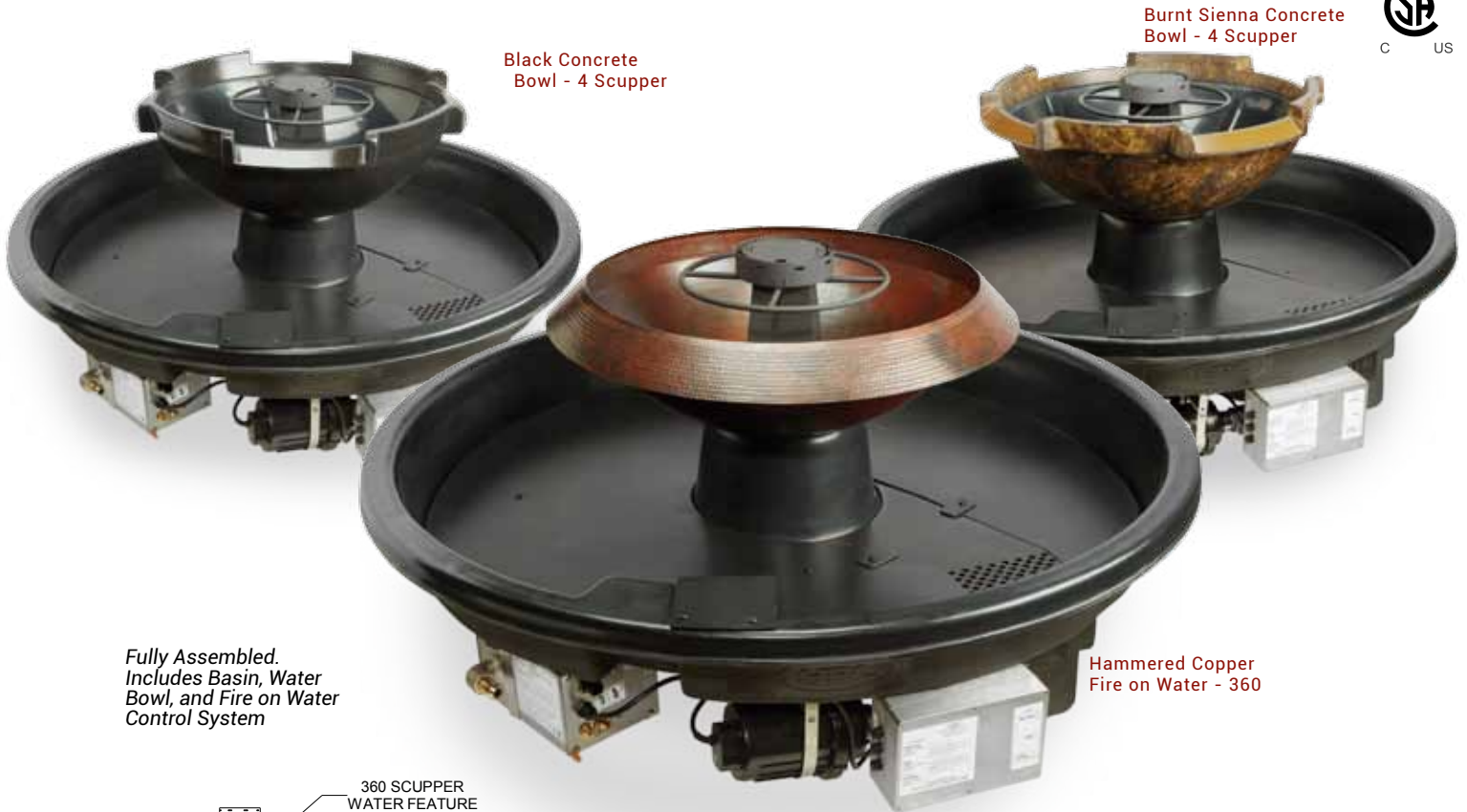

Black Concrete Bowl - 4 Scupper

Burnt Sienna Concrete Bowl - 4 Scupper

Hammered Copper Fire on Water - 360

Fully Assembled.
Includes Basin, Water Bowl, and Fire on Water Control System

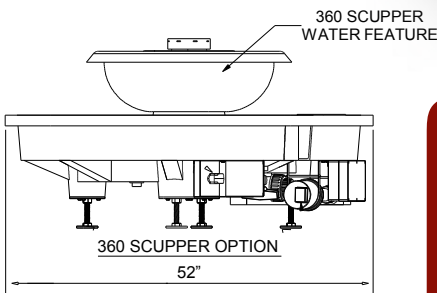

Evolution 360/H2Onfire Enclosure Features:

- Made of lightweight aluminum
- 74" O.D.
- Modular 3 section construction. Bolts together and is easy to lift.
- Adjustable leveling feet
- Lockable access door
- Color: Copper vein with flat black.
- Powder coated. Additional colors coming soon!



WPE-72ROUND-TB/CV



578-G4
Optional Remote Available

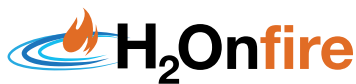

Winner of Vesta Awards Finalist

Specifications - Electronic Ignition

Size: 52" diameter, 14"-18" tall
Burner: Underwater

Color	Bowl Type	Power	Gas type	Models	Max BTU
Concrete Burnt Sienna	4 Scupper	120vac	Natural Gas	FOW52R-MONACO4BS-EI-NG	65k
			Liquid Propane	FOW52R-MONACO4BS-EI-LP	
Concrete Black	4 Scupper	120vac	Natural Gas	FOW52R-MONACO4BL-EI-NG	65k
			Liquid Propane	FOW52R-MONACO4BL-EI-LP	
Copper - Hammered	360	120vac	Natural Gas	FOW52R-CYPRUS360-EI-NG	65k
			Liquid Propane	FOW52R-CYPRUS360-EI-LP	

Need help? Use our fire pit selector at hpcfire.com

Match proper accessories to your fire pit model - see Pg. 65-68.



FIRE PIT ACCESSORIES

EVERYTHING YOU NEED IN ONE PLACE

HPC offers everything you need to turn your fire pit into the work of art and outdoor focal point that it is. With one stop shopping you can spend less time finding media and accessories and more time enjoying your outdoor fire pit.

GLASS WIND GUARDS

HPC provides a high quality glass wind guard specially designed to complement as well as provide additional safety for HPC fire pit inserts of all shapes- round, square, rectangle and linear. These feature a durable tempered glass construction to ensure a long lasting, heat resistant product. Wind guards reduce flame disturbance of your fire pit and prevents loose items from getting too close to the flames.

Features:

Tempered Glass - Heavy duty 3/16" clear glass is tempered to improve durability and allow it to withstand high temperatures. Depending on wind guard size- 4 or 6 sections complete the desired shape.

Brackets- Polished aluminum brackets and plastic support feet provided.



Round Wind Guard



Square Wind Guard



Rectangle Wind Guard



Linear Wind Guard

Specifications

Shape	Size	Model	Height
Round	23"	WG23-RD	6"
	30"	WG30-RD	8" *
	38"	WG38-RD (6 Pieces)	
	48"	WG48-RD (6 Pieces)	
Square	25x25"	WG25-SQ	6"
	31x31"	WG31-SQ	
	37x37"	WG37-SQ	
	43x43"	WG43-SQ	
	49x49"	WG49-SQ	
Rectangle	31x19"	WG31X19-RECT	6"
	37x19"	WG37X19-RECT	
	43x21"	WG43X21-RECT	
	49x21"	WG49X21-RECT	
	61x23"	WG61X23-RECT	
Linear	31x15"	WG31X15-L	6"
	43x15"	WG43X15-L	
	55x15"	WG55X15-L	
	67x15"	WG67X15-L	

* 8" Models while supplies last.
Changing to 6" tall in Fall, 2017

WIND GUARD CLIPS

These are replacement / extension chrome clips for HPC Wind Guards- one clip per pack. Please note if needing a bottom clip, will need rubber foot, also found below.

Model	Size
WG-CC-RD	Replacement Chrome Clip For Round Wind Guards
WG-CC-SQ/RECT	Replacement Chrome Corner Clip For Square & Rectangle Wind Guards
WG-SC	Extension Chrome Straight Clip For Square & Linear Wind Guards-Used for Extending Lengths On Glass Panels



WG-SC



WG-CC-SQ/RECT

WIND GUARD RUBBER FEET

These are replacement rubber feet for HPC Wind Guards- one foot per pack.

Model	Size
WG-RUBBER FOOT-RD	Replacement Rubber Foot For Round Wind Guards
WG-RUBBER FOOT-SQ/RECT	Replacement Rubber Foot For Square & Rectangle Wind Guards
WG-EGS	Extension Glass Support with Rubber Foot



WG-RUBBER FOOT-SQ/RECT

INSTALLATION COLLARS - FOR BOWL PANS

Fire pit installation can be made easier with our installation collar, of an appropriate size, mortared in just below the top course of the enclosure. The collars make the pan and valve box easy to access.

The ID and OD of the installation collars differ by 6" to allow a small space between the side of the pan and the collar as well as 1" or more of the collar to project into the body of the enclosure and be mortared in if desired. The collar should be installed into the enclosure while it is being built. Collar should be 2" to 4" below the top of the enclosure.

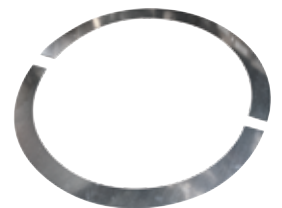

Model	Size	ID	OD
IC19GALV	19" Pan Size	20"	26"
IC25GALV	25" Pan Size	26"	32"
IC31GALV	31" Pan Size	32"	38"

Model	Size	ID	OD
IC37GALV	37" Pan Size	38"	44"
IC43GALV	43" Pan Size	43.5"	49.5"

Need help? Use our fire pit selector at hpcfire.com

Match proper accessories to your fire pit model - see Pg. 65-68.

FIRE PIT ACCESSORIES (CONTINUED)

EVERYTHING YOU NEED IN ONE PLACE

HPC offers everything you need to turn your fire pit into the work of art and outdoor focal point that it is. With one stop shopping you can spend less time finding media and accessories and more time enjoying your outdoor fire pit.

FIRE PIT MEDIA - LAVA ROCK AND CERAMIC FIBER

LAVA ROCK

Time tested, Lava Rock is proven to increase combustion efficiency while maintaining a classy look for any fire pit. The size of each piece of rock varies from 1" to 2". Lava rock is sold in 1/2 cubic foot increments. Serves as an excellent base for our specially designed outdoor logs.

Model	Size
657	1"-2" Size



ROLLED LAVA STONE

Unique finish lava stone rolled smooth. Available in 1/2 cubic foot bags.

Color	Model	Size
Black	857S	1"-2" Size
	857M	2.5"-4.5" Size
Red	858S	1"-2" Size
	858M	2.5"-4.5" Size



CERAMIC RIVER ROCK SERIES

Looking for something other than lava rock or glass? HPC has a third option for media over your outdoor (or indoor) burner, our River Rock Series. These imitation stones are lightweight ceramic fiber, gel cast and designed to take on the outdoor elements. Each set comes with an 84 piece assortment of large and small stones (large pieces are 4 1/2", small pieces are 2 1/2"). One set is 1/2 cubic foot (15 lbs). Available in two styles – black or multi color (light and dark brown, gray, and black)





















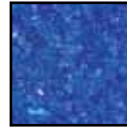









Model	Color	Size
FPR84MC	Multicolor	2.5" - 4.5" Size
FPR84BL	Black	2.5" - 4.5" Size



FIRE PIT MEDIA - DECORATIVE GLASS

HPC has 28 colors to choose from - The glass shown- is 1/4" except for those indicating "5" (1/2")



					
FPGLARCTICBLUE	FPGLAZURIA	FPGLAZURIAREFLE	FPGLBLACK	FPGLBLACKREFL	FPGLBRONZE
					
FPGLBRNZREFL	FPGLBRONZE5	FPGLCHMPINK	FPGLCLEAR	FPGLCLEAR5	FPGLCOBALTBLUE
					
FPGLCOPPER	FPGLEVERGREEN	FPGLEVGRNREFL	FPGLGOLDREFL	FPGLGRAY	FPGLGRAY.5
					
FPGLGRAYREFLEC	FPGLLIGHTGREEN	FPGLORANGE	FPGLPACIFICBLUE	FPGLPACBLUEREFL	FPGLPLATINUM
					
FPGLPURPLE	FPGLRED	FPGLSOLEX	FPGLSTARFIRE	FPGLSTRFIRE5	FPGLTURQUOISE
	<p><i>Sold in 5 lb increments, minimum order 10 lbs (Priced per pound)</i> <i>Note: Glass Orders drop shipped separately from California.</i></p>				
FPGLYELLOW					

NEED HELP? CHECK OUT OUR GLASS CALCULATOR AT HPCFIRE.COM!



Photo Courtesy of Backyard Trends

 Need help? Use our fire pit selector at hpcfire.com

FIRE PIT ACCESSORIES (CONTINUED)

EVERYTHING YOU NEED IN ONE PLACE

HPC offers everything you need to turn your fire pit into the work of art and outdoor focal point that it is. With one stop shopping you can spend less time finding media and accessories and more time enjoying your outdoor fire pit.



OUTDOOR LOGS

Designed specifically for the outdoors, these are sure to enhance the flame in your fire pit. Being ceramic fiber, they develop a glow where the flame is the hottest. These are available in four models, Woodland, Campfire, Western Pine and Linear Birch in 2, 4, 5, 6 and 8 piece sets depending on the size.

Specifications

Style	Model	Piece	Piece Length
Woodland	FPL12W4	4	9"-10"
	FPL17W4	4	11"-13"
	FPL17W5	5	11"-13"
	FPL24W5	5	15"-19"
	FPL24W6	6	15"-19"
	FPL36W6	6	24"-28"
	FPL48W8	8	24"-37"
	FPL48W2	2	37"
Campfire	FPL17C4	4	13"-16"
	FPL24C6	6	14"-17"
Western Pine	FPL17WP5	5	11"-13"
	FPL24WP6	6	15"-19"
	FPL36WP6	6	24"-28"
Linear Birch	FPL14LB5	5	9"-10"
	FPL28LB5	5	14"-28"



Monsma - Michigan

WOODLAND STYLE

This is our most popular style. These have a weathered look of gray and black which looks best when resting on a bed of lava rock. These are available in 2, 4, 5, 6 and 8 piece sets up to our large FPL48 for size 36" fire ring and above fire pits.



CAMPFIRE STYLE

The Campfire set is "the original log set" and are brown and black. These look great resting on a bed of lava rock. These are available in four and six piece sets, up to our large FPL24 size for size 24" and above fire pits.



WESTERN PINE STYLE

New outdoor logs in a beautiful western pine style! The color combination is brown, tan and black creating an amazingly realistic wood feature for your project.



LINEAR BIRCH STYLE

New Birch style logs designed specifically for HPC Linear Burners! When assembled the logs are only 8" wide - multiple sets can be used for long linear applications.



LOG GRATES - FIREPLACE

HPC carries 24", 30", and 36" stainless steel grates. These are made of solid 304 stainless steel, square stock material and are welded at every joint for additional strength.



Model	Size
SFG24	24"x18"x6"
SFG30	30"x18"x6"
SFG36	36"x18"x6"



Beach Stove & Fireplace

Tumblestone



FIRE PIT ACCESSORIES (CONTINUED)

EVERYTHING YOU NEED IN ONE PLACE

HPC offers everything you need to turn your fire pit into the work of art and outdoor focal point that it is. With one stop shopping you can spend less time finding media and accessories and more time enjoying your outdoor fire pit.

FIRE PIT COVERS

ROUND ALUMINUM COVERS - TALL

Now protect your fire feature in style! These lightweight aluminum hard covers are powder coated with UV resistant, high-heat textured black or gloss copper. They are available in two sizes - 32" (15lbs) and 44" (20lbs).

Color	Size	Models	Height	Weight
Copper Vein	32"	FPHC-32C	10"	15 lbs
	44"	FPHC-44C	14"	20 lbs
Black	32"	FPHC-32BL	10"	15 lbs
	44"	FPHC-44BL	14"	20 lbs



ROUND ALUMINUM COVERS - SHORT



Color	Size	Models	Height	Weight
Copper Vein	24"	FPHC-24C	1"	6 lbs
	36"	FPHC-36C		13 lbs
	48"	FPHC-48C		23.5 lbs
Black	24"	FPHC-24BL	1"	6 lbs
	36"	FPHC-36BL		13 lbs
	48"	FPHC-48BL		23.5 lbs

COPPER COVERS



Shape	Finish	Models	Size	Height	Weight
Round	Hammered	FPHC-26TEMP/32MESA	19"	8.5"	7.5 lbs
		FPHC-31TEMPE	32"	5.75"	15 lbs
Square	Hammered	FPHC-36SIERRA-SQ	26"X26"	7"	13 lbs
		FPHC-40SEDONA-SQ	30"X30"	7"	13.5 lbs

STAINLESS STEEL COVERS

These stainless steel covers are constructed of #304, 20g material with handle. Great for covering fire pits without outdoor logs. Linear trough covers are designed specifically for our trough series, be it match lit, manual ignition, or remote electronic ignition models. These are lightweight and have handles for ease of use.

LINEAR

Stainless	Size	Model	Height	Handle	Weight
Brushed	28" x 9.5"	TPHC-24SS	1"	1	11 lbs
	40" x 9.5"	TPHC-36SS	1"	1	13 lbs
	52" x 9.5"	TPHC-48SS	1"	2	15 lbs
	64" x 9.5"	TPHC-60SS	1"	2	18lbs

RECTANGLE

Stainless	Size	Model	Height	Handle	Weight
Brushed	28" x 16"	HPhC-24X12SS	1"	1	16 lbs
	34" x 16"	HPhC-30X12SS	1"	1	18 lbs
	40" x 18"	HPhC-36X14SS	1"	1	20 lbs
	46" x 18"	HPhC-42X14SS	1"	2	22 lbs
	52" x 20"	HPhC-48X16SS	1"	2	24 lbs
	58" x 20"	HPhC-54X16SS	1"	2	28 lbs



Match proper accessories to your fire pit model - see Pg. 65-68.



VINYL COVERS

Made of durable black vinyl and protects your fire pit and enclosure from debris and wet weather. The round covers have elastic and rectangle covers have a pull string at the bottom for ease of applying and removal. NOTE: Skirt Length 10"

ROUND COVERS

Max Size	Models	Fits Enclosures
35"	FPC-35	23" ~ 35"
45"	FPC-45	30" ~ 45"
53"	FPC-53	35" ~ 53"
64"	FPC-64	43" ~ 64"
76"	FPC-76	60" ~ 76"



SQUARE COVERS

Max Size	Models	Fits Enclosures
48" x 48"	FPC-48SQ	36" ~ 48"
60" x 60"	FPC-60SQ	45" ~ 60"



RECTANGLE COVERS

Max Size	Models	Fits Enclosures
48" x 30"	FPC-44X30	34x20" ~ 44x30"
62" x 30"	FPC-62X30	52x20" ~ 62x30"
78" x 40"	FPC-78X40	68x30" ~ 78x40"
90" x 40"	FPC-90X40	80x30" ~ 90x40"
94" x 30"	FPC-94X30	84x20" ~ 94x30"
102" x 40"	FPC-102X40	92x30" ~ 102x40"
114" x 40"	FPC-114X40	104x30" ~ 114x40"
130" x 30"	FPC-130X30	120x20" ~ 130x30"



EVOLUTION 360 AND H2Oonfire COVERS

Model	Style
FPC-84WB	Basin
FPC-35	Bowl



TK TORCH COVER - (FPC-TK TORCH)

TK Torch Cover w/Elastic Hem (3.5" Top Dia x 9.5" Bottom Dia. x 14" Height)



STAINLESS STEEL ACCESS DOORS

Stainless steel access doors are available for all FPPK and MLFPK Hard pipe Models.

Model	Style
AD-RM6X6SS	6x6 Recess Mount
AD-RM8X8SS	8x8 Recess Mount
AD-SM8X8SS	8x8 Surface Mount



ENCLOSURE VENTS

Stainless Steel vents for enclosures.

Material	Style	Size	Model
Stainless	Flat	8"x4"	EV-8X4SS
	Flat	12"x6"	EV-12X6SS
	Louvered	14"x4.5"	EV-14X4.5SS



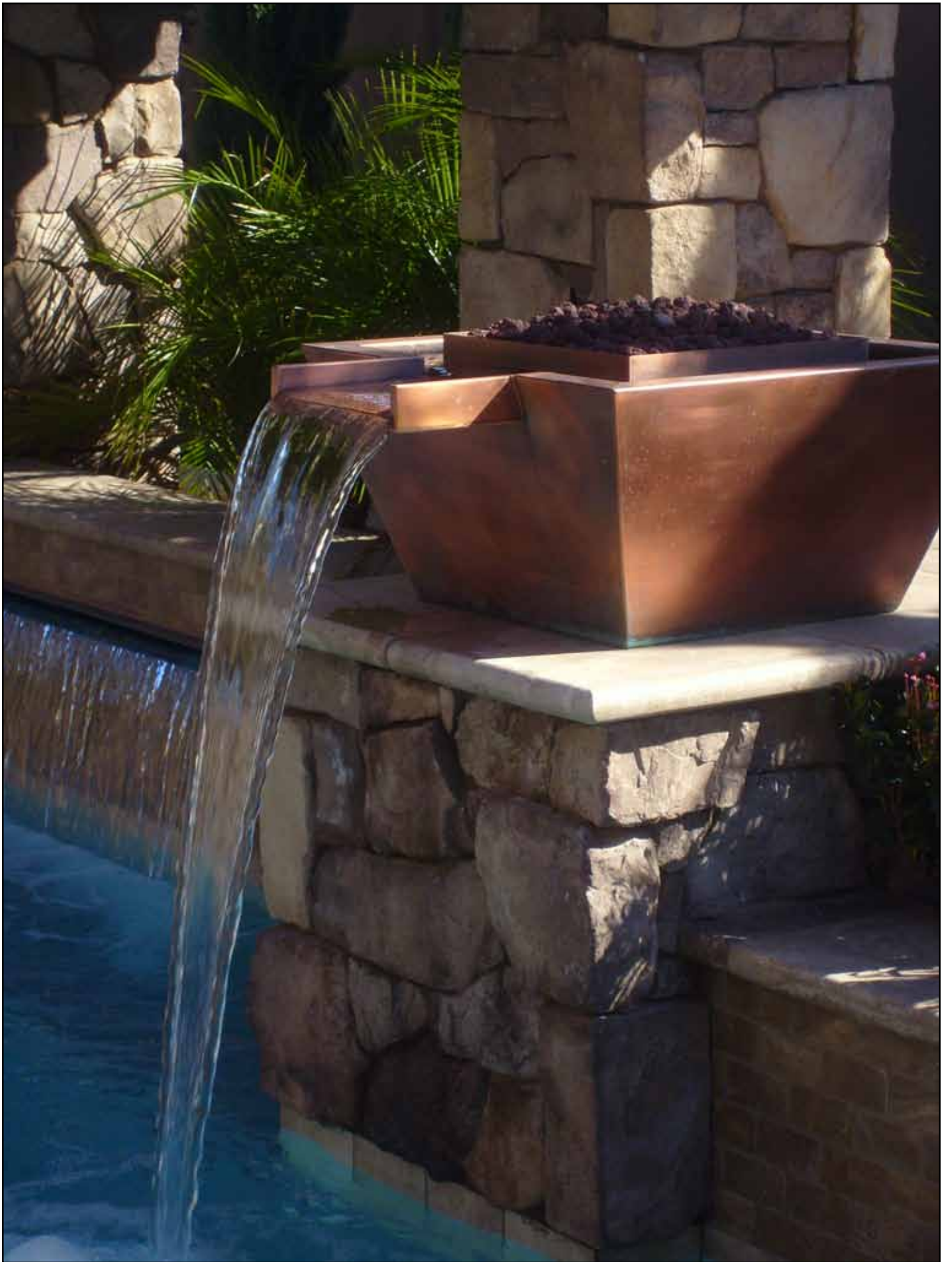







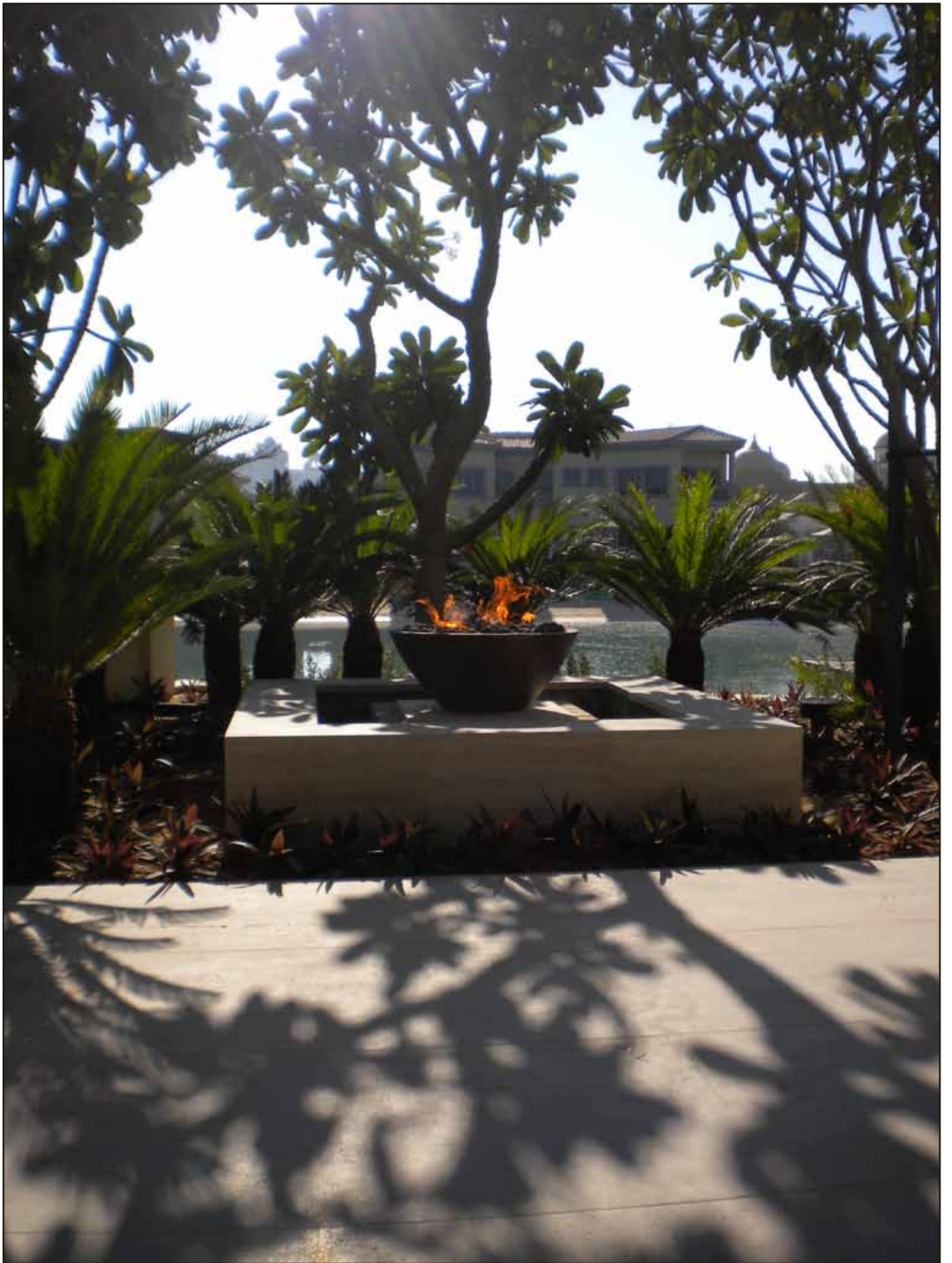



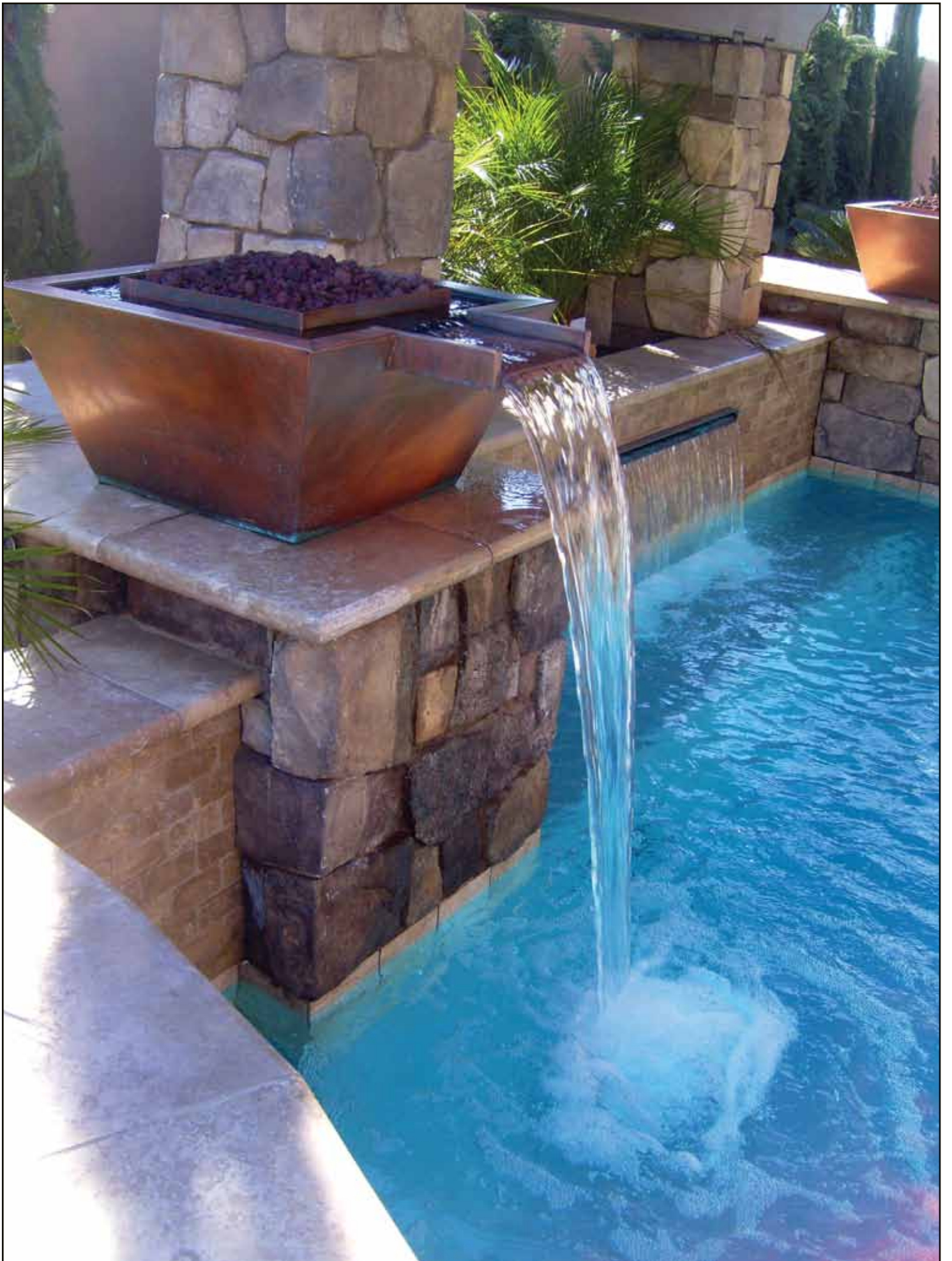

FLEX LINE



STANDARD CAPACITY FLEX LINE

All standard capacity flex lines are 1/2" OD and 3/8" ID with 1/2" female pipe threads on one end and 3/8" male pipe threads on the other.

Model	Length	Max BTU/HR (NG)	Max BTU/HR (LP)	Flare Size	Fittings Included (Two)
SSC6	6"	110,000	177,000	1/2"	3/8" MIP, 1/2" FIP
SSC12	12"	102,000	163,200	1/2"	3/8" MIP, 1/2" FIP
SSC18	18"	93,000	148,960	1/2"	3/8" MIP, 1/2" FIP
SSC24	24"	85,000	136,000	1/2"	3/8" MIP, 1/2" FIP
SSC30	30"	77,000	123,360	1/2"	3/8" MIP, 1/2" FIP
SSC36	36"	71,000	113,760	1/2"	3/8" MIP, 1/2" FIP
SSC48	48"	60,500	96,800	1/2"	3/8" MIP, 1/2" FIP



HIGH CAPACITY FLEX LINE

All high capacity flex lines are 5/8" OD and 1/2" ID with 1/2" female pipe threads on one end and 1/2" male pipe threads on the other.

Model	Length	Max BTU/HR (NG)	Max BTU/HR (LP)	Flare Size	Fittings Included (Two)
SSC-HC12	12"	180,000	288,000	3/4"	1/2" MIP, 1/2" FIP
SSC-HC18	18"	164,000	262,700	3/4"	1/2" MIP, 1/2" FIP
SSC-HC24	24"	150,000	240,000	3/4"	1/2" MIP, 1/2" FIP
SSC-HC30	30"	136,000	217,600	3/4"	1/2" MIP, 1/2" FIP



ULTRA HIGH CAPACITY FLEX LINE

Model	Length	Max BTU/HR (NG)	Max BTU/HR (LP)	Flare Size	Fittings Included (Two)
SSC-HHC24	24"	291,000	465,400	1"	3/4" MIP, 3/4" FIP
SSC-HHC36	36"	256,000	409,400	1"	3/4" MIP, 3/4" FIP

TRANQUIL WHISTLE-FREE FLEX LINE

HPC has been a long time supplier of reliable, maintenance-free flex lines. We offer our Tranquil Flex Line Series to eliminate the nuisance whistling found on those tough installs. Sizes available in standard capacity are 12", 18", 24", and 30" lengths. These are stainless steel with 3/8" ID and are in stock and ready for shipment.

Model	Length	Max BTU/HR (NG)	Max BTU/HR (LP)	Flare Size	Fittings Included (Two)
SSC-W12	12"	102,000	163,200	1/2"	3/8" MIP, 1/2" FIP
SSC-W18	18"	93,000	148,960	1/2"	3/8" MIP, 1/2" FIP
SSC-W24	24"	85,000	136,000	1/2"	3/8" MIP, 1/2" FIP
SSC-W30	30"	77,000	123,360	1/2"	3/8" MIP, 1/2" FIP



TRANQUIL WHISTLE-FREE, STANDARD CAPACITY (BLACK)

Model	Length	Max BTU/HR (NG)	Max BTU/HR (LP)	Flare Size	Fittings Included (Two)
SSCB-W18	18"	93,000	148,960	1/2"	3/8" MIP, 1/2" FIP
SSCB-W24	24"	85,000	136,000	1/2"	3/8" MIP, 1/2" FIP
SSCB-W30	30"	77,000	123,360	1/2"	3/8" MIP, 1/2" FIP

* Natural Gas maximum Btu/hr: Straight Length Capacity; 0.64 SG, 1,000 Btu per Cu. Ft. at .5 water column pressure drop

** Liquid Propane Maximum Btu/hr: Straight Length Capacity; 1.55 SG, 2,500 Btu per Cu. Ft. at .5 water column pressure drop



Photo Courtesy of AEI Gas - Florida

FIRE PIT COMPONENTS (CONTINUED)

EVERYTHING THE DESIGNER IN YOU COULD DREAM OF

Have your heart on building your dream pit? We have you covered on all the bases from outdoor burners to regulators. We will make sure you start off on the right foot.

DECORATIVE KEY VALVES

Key Valve Part Numbers: Key Valves are numbered as either Angled or Straight, and based off of color. For example, MAFB is described as Manual Angled Flat Black. MSFB would be Manual Straight Flat Black.

STANDARD CAPACITY VALVES (1/2")

1/4 Turn angle or straight manual ball valve with flange and key. 1/2" inlet and outlet. For floor or wall mounting.

Recommended for gas shut off of 150k Btu or less

HIGH CAPACITY VALVES (3/4")

1/4 Turn angle or straight manual ball valve with flange and key. 3/4" inlet and outlet. For floor or wall mounting.

Recommended for gas shut off of 400k Btu or less

DANTE VALVE



CHROME FLANGE/ KEY

Valve	Inlet / Outlet	Models
Angle	1/2"	MACB
	3/4"	MACB-HC
Straight	1/2"	MSCB
	3/4"	MSCB-HC

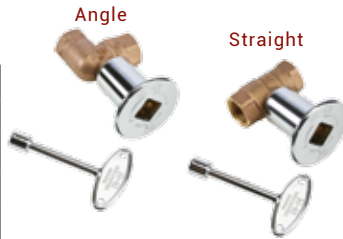

BRASS FLANGE/ KEY

Valve	Inlet / Outlet	Models
Angle	1/2"	MABB
	3/4"	MABB-HC
Straight	1/2"	MSBB
	3/4"	MSBB-HC



FLAT BLACK FLANGE/ KEY

Valve	Inlet / Outlet	Models
Angle	1/2"	MAFB
	3/4"	MAFB-HC
Straight	1/2"	MSFB
	3/4"	MSFB-HC



PEWTER FLANGE/ KEY

Valve	Inlet / Outlet	Models
Angle	1/2"	MAPW
	3/4"	MAPW-HC
Straight	1/2"	MSPW
	3/4"	MSPW-HC



ANTIQUE BRASS FLANGE/ KEY

Valve	Inlet / Outlet	Models
Angle	1/2"	MAAB
	3/4"	MAAB-HC
Straight	1/2"	MSAB
	3/4"	MSAB-HC



ANTIQUE COPPER FLANGE/ KEY

Valve	Inlet / Outlet	Models
Angle	1/2"	MAAC
	3/4"	MAAC-HC
Straight	1/2"	MSAC
	3/4"	MSAC-HC



FLANGE AND KEY ONLY

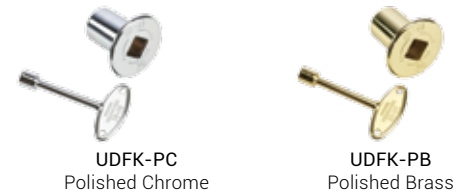
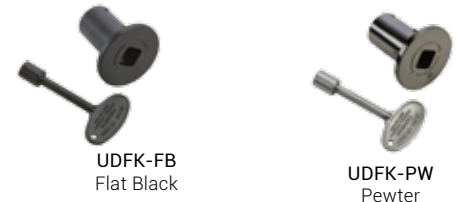
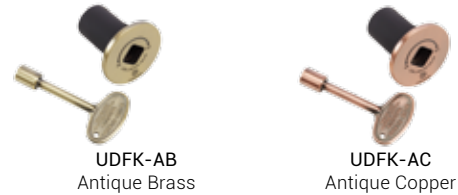

KEYS

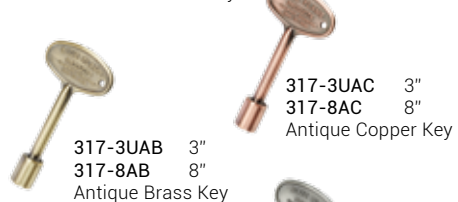

FLANGE ONLY

304 L Polished Chrome Flange
 306 L Polished Brass Flange







 Need help? Use our fire pit selector at hpcfired.com



APPENDIX (EI SERIES)



ELECTRONIC IGNITION INSERTS

THIS CHART WILL HELP YOU DECIDE WHAT SIZE AND HOW MUCH OF AN ACCESSORY IS NEEDED

Models	OPTIONAL COMPONENTS				MEDIA		
	Vinyl Covers** (Pg. 51)	Outdoor Logs*** (Pg. 48)	Wind Guards**** (Pg. 45)	Install Collar (Pg. 45)	Lava Rock (Pg. 46)	Decorative Glass (Pg. 47)	River Rock (Pg. 46)
ROUND BOWL INSERTS (PG. 12)					1 Bag ~ 1/2 cu. ft.	(Lbs)	(Box)
13SSEI	FPC-35	FPL12xx	WG23-D	N/A	1 Bag	20	1
PENTA19EI	FPC-45	FPL17xx	WG30-D	IC19GALV	2 Bags	35	1
PENTA25EI	FPC-45	FPL24xx	WG30-D	IC25GALV	2 Bags	55	2
PENTA31EI	FPC-53	FPL24xx	WG38-D	IC31GALV	4 Bags	85	3
PENTA37EI	FPC-53	FPL36xx	WG48-D	IC37GALV	4 Bags	120	4
PENTA43EI	FPC-64	FPL48xx	WG48-D	IC43GALV	4 Bags	155	5
ROUND FLAT INSERTS (PG. 14)							
14FSSEI	FPC-35	FPL12xx	WG23-D	N/A	1 Bag	25	1
PENTA18EI	FPC-45	FPL17xx	WG23-D	N/A	2 Bags	30	1
PENTA24EI	FPC-45	FPL24xx	WG30-D	N/A	2 Bags	50	2
PENTA30EI	FPC-53	FPL24xx	WG38-D	N/A	2 Bags	75	3
PENTA36EI	FPC-53	FPL36xx	WG38-D	N/A	4 Bags	110	4
PENTA42EI	FPC-64	FPL48xx	WG48-D	N/A	4 Bags	150	5
PENTA54EI	FPC-76	FPL48xx	N/A	N/A	6 Bags	250	8
SQUARE FLAT INSERTS (PG. 16)							
18FSSEI-SQ	FPC-48SQ	FPL17xx	WG25-SQ	N/A	2 Bags	35	1
24FSSEI-SQ	FPC-48SQ	FPL24xx	WG31-SQ	N/A	2 Bags	65	2
30FSSEI-SQ	FPC-60SQ	FPL24xx	WG37-SQ	N/A	2 Bags	100	3
36FSSEI-SQ	FPC-60SQ	FPL36xx	WG43-SQ	N/A	6 Bags	135	4
42FSSEI-SQ	FPC-60SQ	FPL48xx	WG49-SQ	N/A	6 Bags	185	4
RECTANGLE BOWL INSERTS (PG. 18)							
24X12SSEI-H	FPC-62X30	FPL17xx	WG31X19-RECT	N/A	2 Bags	35	1
30X12SSEI-H	FPC-62X30	FPL24xx	WG37X19-RECT	N/A	2 Bags	40	2
36X14SSEI-H	FPC-78X40	FPL24xx	WG43X21-RECT	N/A	2 Bags	55	2
42X14SSEI-H	FPC-78X40	FPL36xx	WG49X21-RECT	N/A	2 Bags	65	3
54X16SSEI-H	FPC-78X40	FPL36xx	WG61X23-RECT	N/A	4 Bags	95	3
66X16SSEI-H	FPC-90X40	FPL36xx	N/A	N/A	6 Bags	115	4
78X16SSEI-H	FPC-102X40	FPL36xx (2)	N/A	N/A	6 Bags	135	4
90X16SSEI-H	FPC-114X40	FPL36xx (2)	N/A	N/A	8 Bags	160	5
LINEAR INTERLINK INSERTS (PG. 24)							
25X8SSEI-L	FPC-44X30	FPL14xx	WG31X15-L	N/A	1 Bag	20	1
37X8SSEI-L	FPC-62X30	FPL28xx	WG43X15-L	N/A	2 Bags	25	1
49X8SSEI-L	FPC-62X30	FPL14xx (2)	WG55X15-L	N/A	2 Bags	35	1
61X8SSEI-L	FPC-94X30	FPL14xx (2)	WG67X15-L	N/A	2 Bags	40	2
73X8SSEI-L	FPC-94X30	FPL28xx (2)	N/A	N/A	4 Bags	50	2
97X8SSEI-L	FPC-130X30	FPL28xx (3)	N/A	N/A	4 Bags	60	2
121X8SSEI-L	FPC-130X30	FPL28xx (4)	N/A	N/A	6 Bags	75	3
LINEAR TROUGH INSERTS (PG. 22)							
24SSEI-TRGH	FPC-44X30	FPL14xx	WG31X15-L	N/A	2 Bags	20	1
36SSEI-TRGH	FPC-62X30	FPL28xx	WG43X15-L	N/A	2 Bags	25	1
48SSEI-TRGH	FPC-62X30	FPL14xx (2)	WG55X15-L	N/A	2 Bags	35	1
60SSEI-TRGH	FPC-94X30	FPL28xx (2)	WG67X15-L	N/A	2 Bags	40	1
72SSEI-TRGH	FPC-94X30	FPL28xx (3)	N/A	N/A	2 Bags	50	2

Notes: **Vinyl Covers: Part numbers listed are commonly used sizes- other vinyl sizes and Hard Covers available (Pg. 51).
 ***Outdoor Logs: Part numbers listed are commonly used sizes- other sizes available (Pg. 48).
 ****Wind Guards: Part numbers listed are commonly used sizes- other sizes available (Pg. 45).

APPENDIX (EI SERIES) - (CONTINUED)

Models	OPTIONAL COMPONENTS				MEDIA		
	Vinyl Covers** (Pg. 51)	Outdoor Logs*** (Pg. 48)	Wind Guards**** (Pg. 45)	Install Collar (Pg. 45)	Lava Rock (Pg. 46)	Decorative Glass (Pg. 47)	River Rock (Pg. 46)
S-FIRE BURNER INSERTS (PG. 20)					1 Bag ~ 1/2 cu. ft.	(Lbs)	(Box)
36X14SSEI-S	FPC-78X40	FPL24xx	WG43X21-RECT	N/A	2 Bags	55	2
42X14SSEI-S	FPC-78X40	FPL36xx	WG49X21-RECT	N/A	2 Bags	65	3
54X16SSEI-S	FPC-78X40	FPL36xx	WG61X23-RECT	N/A	4 Bags	95	3
66X16SSEI-S	FPC-90X40	FPL36xx	N/A	N/A	6 Bags	115	4
78X16SSEI-S	FPC-102X40	FPL36xx	N/A	N/A	6 Bags	135	4

Notes: **Vinyl Covers: Part numbers listed are commonly used sizes- other vinyl sizes and Hard Covers available (Pg. 51).
 ***Outdoor Logs: Part numbers listed are commonly used sizes- other sizes available (Pg. 48).
 ****Wind Guards: Part numbers listed are commonly used sizes- other sizes available (Pg. 45).



Photo Courtesy of Pridemark Residential - Arizona

APPENDIX (FPPK SERIES)



PUSH BUTTON / FLAME SENSE INSERTS

THIS CHART WILL HELP YOU DECIDE WHAT SIZE AND HOW MUCH OF AN ACCESSORY IS NEEDED

Models	OPTIONAL COMPONENTS					MEDIA		
	Gas Input Flex Line* (Pg. 59)	Vinyl Covers** (Pg. 51)	Outdoor Logs*** (Pg. 48)	Wind Guards**** (Pg. 45)	Install Collar (Pg. 45)	Lava Rock (Pg. 46)	Decorative Glass (Pg. 47)	River Rock (Pg. 46)
ROUND BOWL INSERTS (PG. 13)						1 Bag ~ 1/2 cu. ft	(Lbs)	(Box)
FPPK13	SSC-HC24	FPC-35	FPL12xx	WG23-D	N/A	1 Bag	20	1
PENTA19FPPK	SSC-HC24	FPC-45	FPL17xx	WG30-D	IC19GALV	2 Bags	35	1
PENTA25FPPK	SSC-HC24	FPC-45	FPL24xx	WG30-D	IC25GALV	2 Bags	55	2
PENTA31FPPK	SSC-HC24	FPC-53	FPL24xx	WG38-D	IC31GALV	4 Bags	85	3
PENTA37FPPK	SSC-HC24	FPC-53	FPL36xx	WG48-D	IC37GALV	4 Bags	120	4
ROUND FLAT INSERTS (PG. 15)								
FPPK14	SSC-HC24	FPC-35	FPL12xx	WG23-D	N/A	1 Bag	25	1
PENTA18FPPK	SSC-HC24	FPC-45	FPL17xx	WG23-D	N/A	2 Bags	30	1
PENTA24FPPK	SSC-HC24	FPC-45	FPL24xx	WG30-D	N/A	2 Bags	50	2
PENTA30FPPK	SSC-HC24	FPC-53	FPL24xx	WG38-D	N/A	2 Bags	75	3
PENTA36FPPK	SSC-HC24	FPC-53	FPL36xx	WG38-D	N/A	4 Bags	110	4
SQUARE FLAT INSERTS (PG. 17)								
FPPK18-SQ	SSC-HC24	FPC-48SQ	FPL17xx	WG25-SQ	N/A	2 Bags	35	1
FPPK24-SQ	SSC-HC24	FPC-48SQ	FPL24xx	WG31-SQ	N/A	2 Bags	65	2
FPPK30-SQ	SSC-HC24	FPC-60SQ	FPL24xx	WG37-SQ	N/A	2 Bags	100	3
FPPK36-SQ	SSC-HC24	FPC-60SQ	FPL36xx	WG43-SQ	N/A	6 Bags	135	4
FPPK42-SQ	SSC-HC24	FPC-60SQ	FPL48xx	WG49-SQ	N/A	6 Bags	185	4
RECTANGLE BOWL INSERTS (PG. 19)								
FPPK24X12-H	SSC-HC24	FPC-62X30	FPL17xx	WG31X19-RECT	N/A	2 Bags	35	1
FPPK30X12-H	SSC-HC24	FPC-62X30	FPL24xx	WG37X19-RECT	N/A	2 Bags	40	2
FPPK36X14-H	SSC-HC24	FPC-78X40	FPL24xx	WG43X21-RECT	N/A	2 Bags	55	2
FPPK42X14-H	SSC-HC24	FPC-78X40	FPL36xx	WG49X21-RECT	N/A	2 Bags	65	3
FPPK54X16-H	SSC-HC24	FPC-78X40	FPL36xx	WG61X23-RECT	N/A	4 Bags	95	3
LINEAR INTERLINK INSERTS (PG. 25)								
FPPK25X8-L	SSC-HC24	FPC-44X30	FPL14xx	WG31X15-L	N/A	1 Bag	20	1
FPPK37X8-L	SSC-HC24	FPC-62X30	FPL28xx	WG43X15-L	N/A	2 Bags	25	1
FPPK49X8-L	SSC-HC24	FPC-62X30	FPL14xx (2)	WG55X15-L	N/A	2 Bags	35	1
FPPK61X8-L	SSC-HC24	FPC-94X30	FPL14xx (2)	WG67X15-L	N/A	2 Bags	40	2
FPPK73X8-L	SSC-HC24	FPC-94X30	FPL28xx (2)	N/A	N/A	4 Bags	50	2
FPPK97X8-L	SSC-HC24	FPC-130X30	FPL28xx (3)	N/A	N/A	4 Bags	60	2
LINEAR TROUGH INSERTS (PG. 23)								
FPPK24-TRGH	SSC-HC24	FPC-44X30	FPL14xx	WG31X15-L	N/A	2 Bags	20	1
FPPK36-TRGH	SSC-HC24	FPC-62X30	FPL28xx	WG43X15-L	N/A	2 Bags	20	1
FPPK48-TRGH	SSC-HC24	FPC-62X30	FPL14xx (2)	WG55X15-L	N/A	2 Bags	30	1
FPPK60-TRGH	SSC-HC24	FPC-94X30	FPL28xx (2)	WG67X15-L	N/A	2 Bags	40	1
FPPK72-TRGH	SSC-HC24	FPC-94X30	FPL28xx (3)	N/A	N/A	2 Bags	50	2
S-FIRE BURNER INSERTS (PG. 21)								
36X14SSEI-S	SSC-HC24	FPC-78X40	FPL24xx	WG43X21-RECT	N/A	2 Bags	55	2
42X14SSEI-S	SSC-HC24	FPC-78X40	FPL36xx	WG49X21-RECT	N/A	2 Bags	65	3
54X16SSEI-S	SSC-HC24	FPC-78X40	FPL36xx	WG61X23-RECT	N/A	4 Bags	95	3

Notes: *Gas Input Flex Line: Part numbers listed are 24" length- other lengths available. Flex Btu confirmation required. (Pg. 59).

**Vinyl Covers: Part numbers listed are commonly used sizes- other vinyl sizes and Hard Covers available (Pg. 51).

***Outdoor Logs: Part numbers listed are commonly used sizes- other sizes available (Pg. 48).

****Wind Guards: Part numbers listed are commonly used sizes- other sizes available (Pg. 45).

APPENDIX (MLFPK SERIES)

MATCH LIT INSERTS

THIS CHART WILL HELP YOU DECIDE WHAT SIZE AND HOW MUCH OF AN ACCESSORY IS NEEDED

Models	OPTIONAL COMPONENTS					MEDIA		
	Gas Input Flex Line* (Pg. 59)	Vinyl Covers** (Pg. 51)	Outdoor Logs*** (Pg. 48)	Wind Guards**** (Pg. 45)	Install Collar (Pg. 45)	Lava Rock (Pg. 46)	Decorative Glass (Pg. 47)	River Rock (Pg. 46)
ROUND BOWL INSERTS (PG. 13)						1 Bag ~ 1/2 cu. ft.	(Lbs)	(Box)
PENTA13MLFPK	SSC24	FPC-35	FPL12xx	WG23-D	N/A	1 Bag	20	1
PENTA19MLFPK	SSC24	FPC-45	FPL17xx	WG30-D	IC19GALV	2 Bags	35	1
PENTA25MLFPK	SSC24	FPC-45	FPL24xx	WG30-D	IC25GALV	2 Bags	55	2
PENTA31MLFPK	SSC24	FPC-53	FPL24xx	WG38-D	IC31GALV	4 Bags	85	3
ROUND FLAT INSERTS (PG. 15)								
PENTA14MLFPK	SSC24	FPC-35	FPL12xx	WG23-D	N/A	1 Bag	25	1
PENTA18MLFPK	SSC24	FPC-45	FPL17xx	WG23-D	N/A	2 Bags	30	1
PENTA24MLFPK	SSC24	FPC-45	FPL24xx	WG30-D	N/A	2 Bags	50	2
PENTA30MLFPK	SSC24	FPC-53	FPL24xx	WG38-D	N/A	2 Bags	75	3
SQUARE FLAT INSERTS (PG. 17)								
MLFPK18-SQ	SSC24	FPC-48SQ	FPL17xx	WG25-SQ	N/A	2 Bags	35	1
MLFPK24-SQ	SSC24	FPC-48SQ	FPL24xx	WG31-SQ	N/A	2 Bags	65	2
MLFPK30-SQ	SSC24	FPC-60SQ	FPL24xx	WG37-SQ	N/A	2 Bags	100	3
RECTANGLE BOWL INSERTS (PG. 19)								
MLFPK24X12-H	SSC24	FPC-62X30	FPL17xx	WG31X19-RECT	N/A	2 Bags	35	1
MLFPK30X12-H	SSC24	FPC-62X30	FPL24xx	WG37X19-RECT	N/A	2 Bags	40	2
MLFPK36X14-H	SSC24	FPC-78X40	FPL24xx	WG43X21-RECT	N/A	2 Bags	55	2
LINEAR INTERLINK INSERTS (PG. 25)								
MLFPK25X8-L	SSC24	FPC-44X30	FPL14xx	WG31X15-L	N/A	1 Bag	20	1
MLFPK37X8-L	SSC24	FPC-62X30	FPL28xx	WG43X15-L	N/A	2 Bags	25	1
MLFPK49X8-L	SSC24	FPC-62X30	FPL14xx (2)	WG55X15-L	N/A	2 Bags	35	1
LINEAR TROUGH INSERTS (PG. 23)								
MLFPK24-TRGH	SSC24	FPC-44X30	FPL14xx	WG31X15-L	N/A	2 Bags	20	1
MLFPK36-TRGH	SSC24	FPC-62X30	FPL28xx	WG43X15-L	N/A	2 Bags	25	1
MLFPK48-TRGH	SSC24	FPC-62X30	FPL14xx (2)	WG55X15-L	N/A	2 Bags	35	1
S-FIRE BURNER INSERTS (PG. 21)								
36X14SSEI-S	SSC24	FPC-78X40	FPL24xx	WG43X21-RECT	N/A	2 Bags	55	2

Notes: *Gas Input Flex Line: Part numbers listed are 24" length- other lengths available. Flex Btu confirmation required. (Pg. 59).

**Vinyl Covers: Part numbers listed are commonly used sizes- other vinyl sizes and Hard Covers available (Pg. 51).

***Outdoor Logs: Part numbers listed are commonly used sizes- other sizes available (Pg. 48).

****Wind Guards: Part numbers listed are commonly used sizes- other sizes available (Pg. 45).



Photo Courtesy of Goddard

POINT OF PURCHASE PRODUCTS

HPC DISPLAY KIOSK



REPRESENT HPC IN STYLE WITH A KIOSK KIT!

HPC offers a very appealing and educational kiosk for your store front. It is constructed of long-lasting steel and powder coated for a professional look- and is very simple to assemble. The kiosk explains in Layman terms how to select and construct the style, shape, and technology of their fire pit with the help of the Dealer while using HPC fire pit inserts. The Kiosk Kit includes the kiosk stand, burners with placards, a laminated flip-book and several take-home brochures (replenished at no cost).



Flip Book Cover



Open Flip Book



Take-Home Brochures

 Need help? Use our fire pit selector at hpcfire.com

POINT OF PURCHASE PRODUCTS



HPC DISPLAY KIOSK

Need to display your fire pit inserts? Our steel display stands give full access to the insert for your customer to look at every detail!

**FOR DISPLAY ONLY! NOT FOR
OUTDOOR INSTALLATION**



DS25-ROUND

For use with 25" Round Insert



DS30x12-HBURNER

For use with 30x12" H-Burner Insert



DS36-TRGH

For use with 36" Trough
Insert



DS49X8-LINEAR

For use with 49"x8"
Interlink Insert

POINT OF PURCHASE BANNER



BANNER KIT

48"x30" Banner for storefront display

3050 Plainfield Road
Kettering Oh, 45432

 937.436.9800

 HPCfire.com

 info@hpcfire.com



Rustic Decor - Arizona



SE Design and Construction -
Pennsylvania



Goddard

SHOW US YOUR PROJECTS

We want your pictures! HPC is constantly looking for new finished installations and interesting projects to feature in our advertising. Let us promote your company by sending us images of your projects and installs, and get some credit on your HPC account for doing so!

- HPC Products installed and finished with enclosure, media, logs, etc.
- High resolution .tif or .jpeg photos wanted!
- Burning shots at Dusk or Dawn preferred.
- Send to pics@hpcf.com, earn \$25 credit per installation! (\$50 Maximum)
- Send multiple shots and angles of your best installations and receive up to \$50 credit.
- Please include P.O. number in subject line of email.
- NOTE: This is not available if receiving live burn program credit (Pg 3)

